

10 ●

10

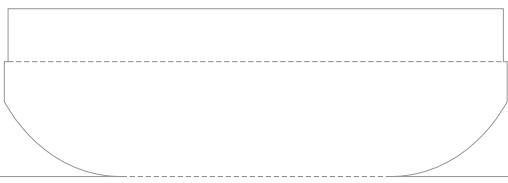

14

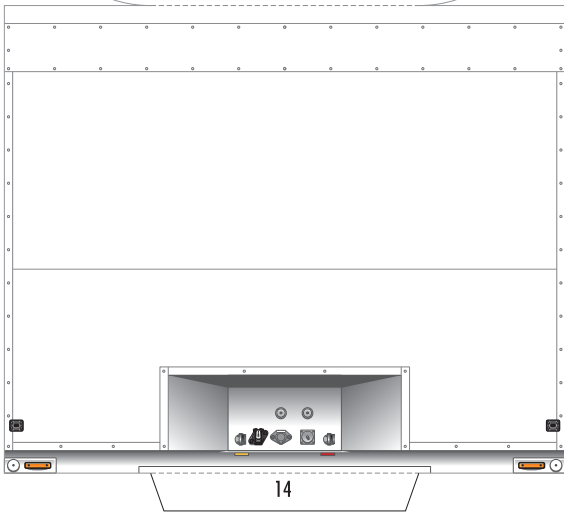

14

- 切る線
 - - - 山折り
 - · - 谷折り
 - ◻ ● のりしろ
 - 貼り合わせガイド線
 - > ✂ 切り抜くところ
 - ▶ ✂ 切り込みを入れるところ
- Lは左側、Rは右側を表しています

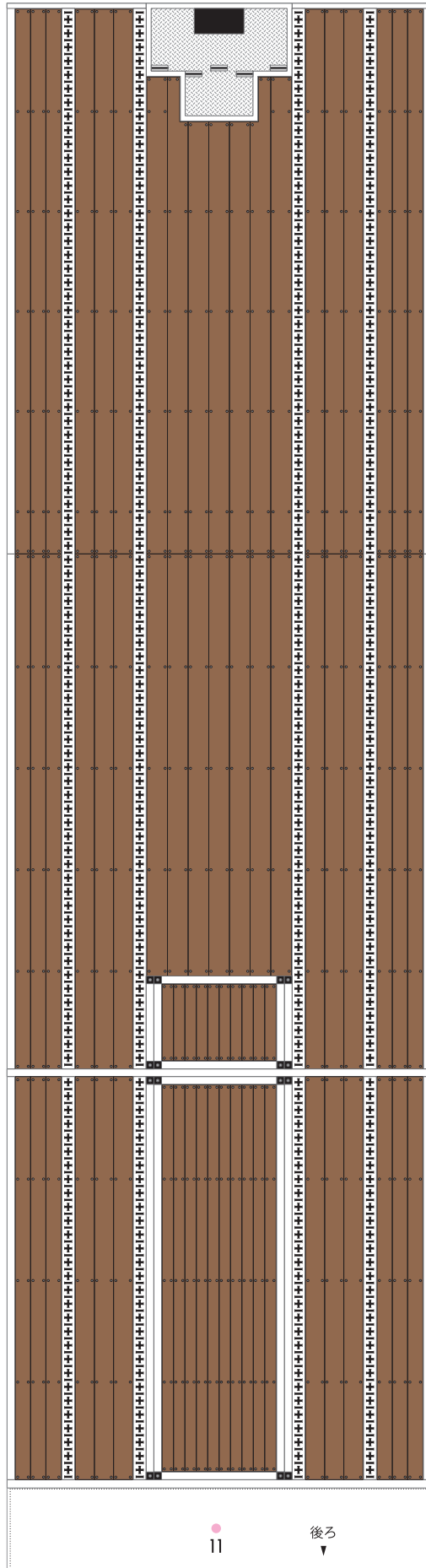

11 ●

後ろ



11

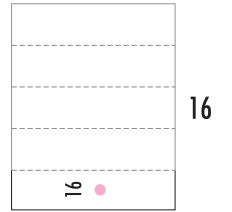

16 ●

16

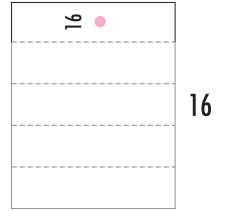

16 ●

16

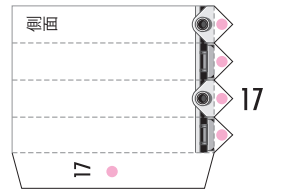

側面

17 ●

17

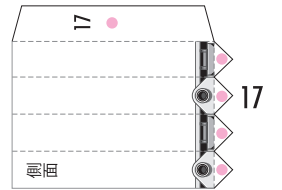

17 ●

側面

17



18



18

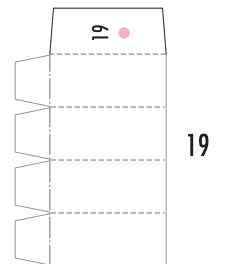

19 ●

19

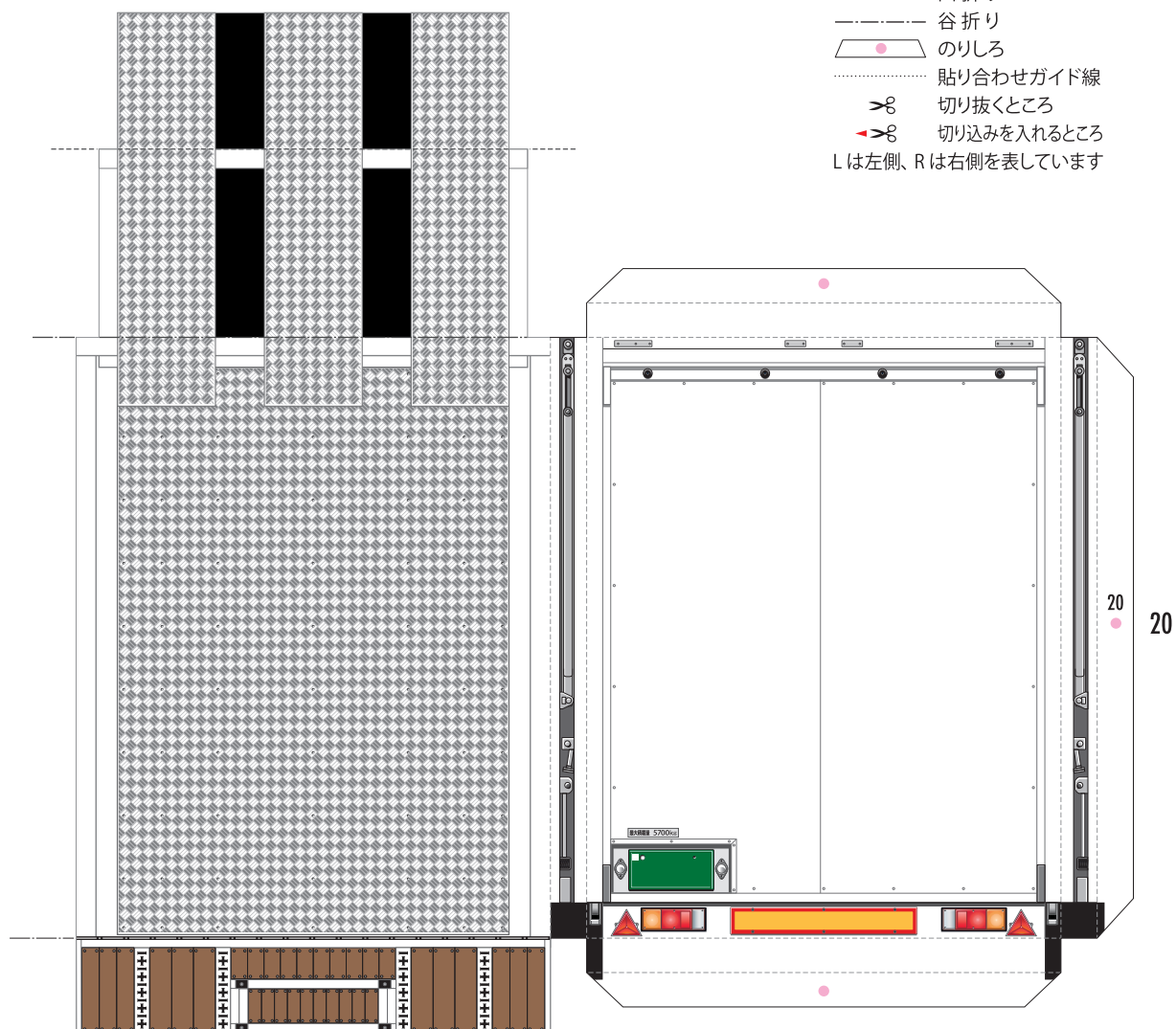
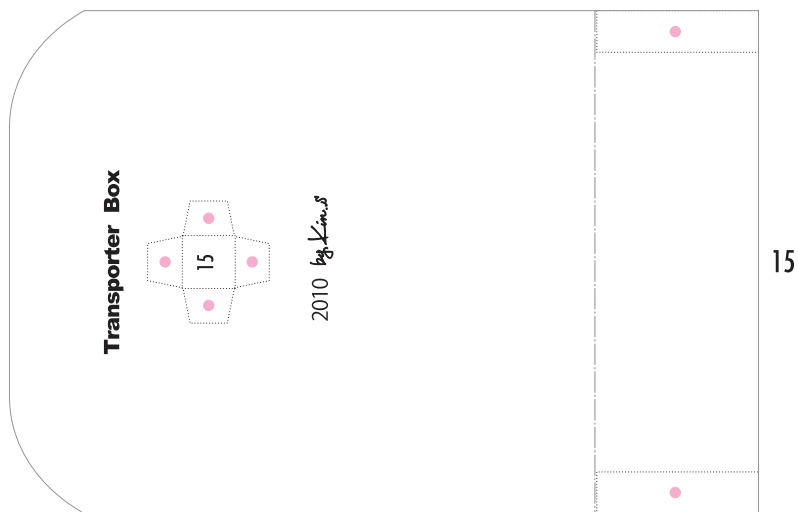

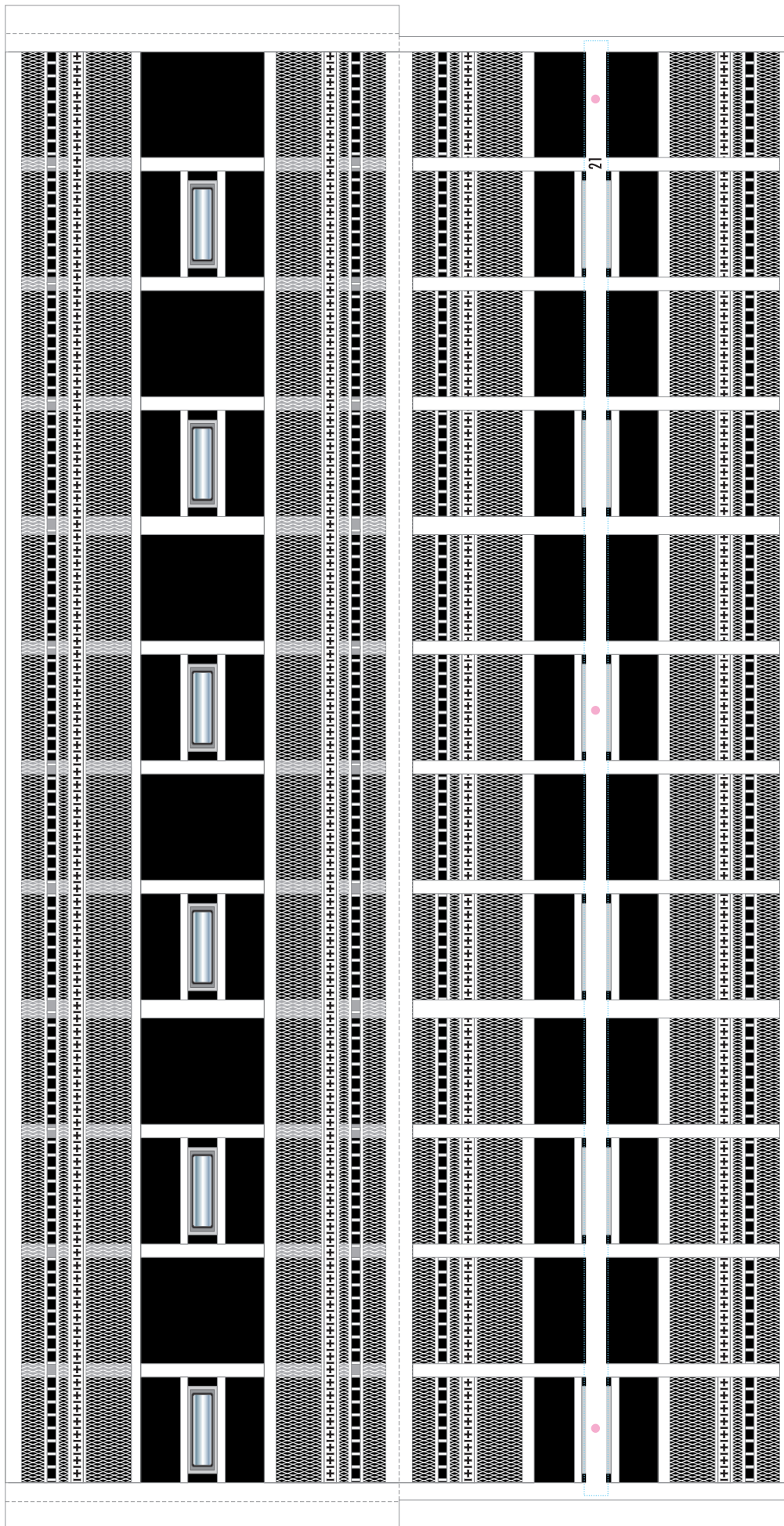

21



22

22

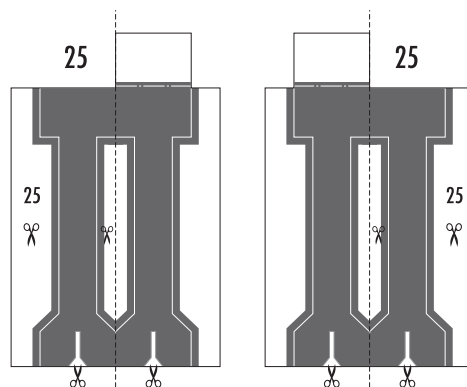
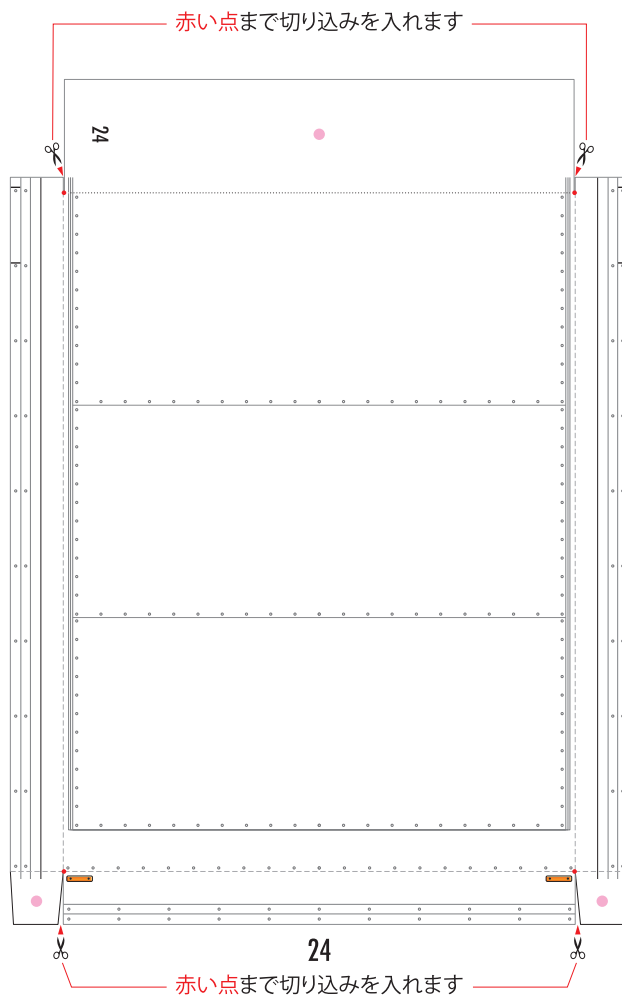
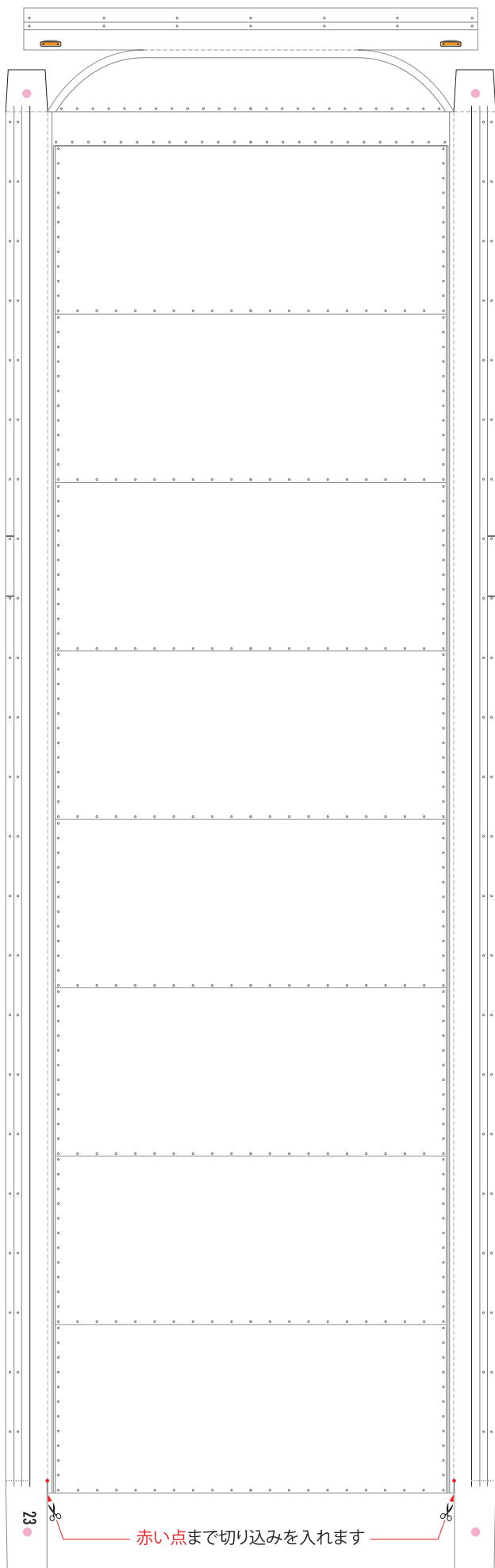

外側の線を切り取り、中央の山折り線に沿って裏同士を貼り合わせてから、切取ります

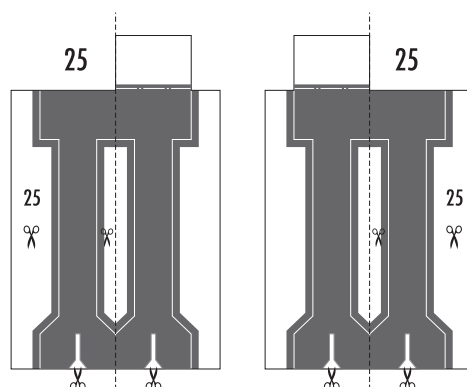

HONDA HSV-010GT

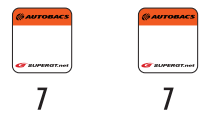
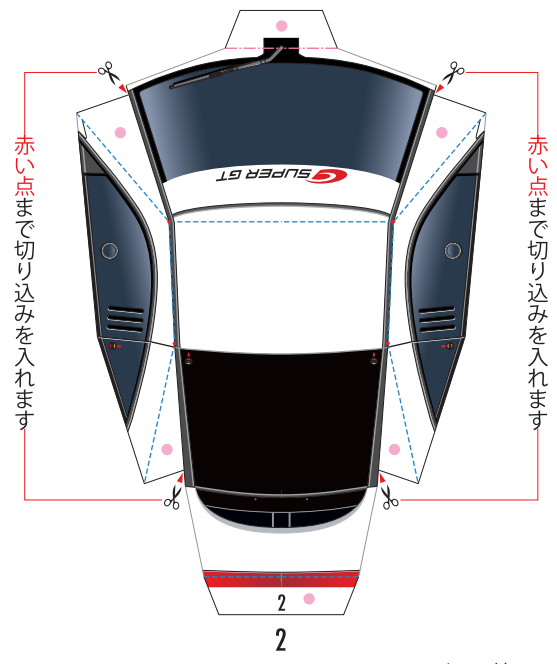
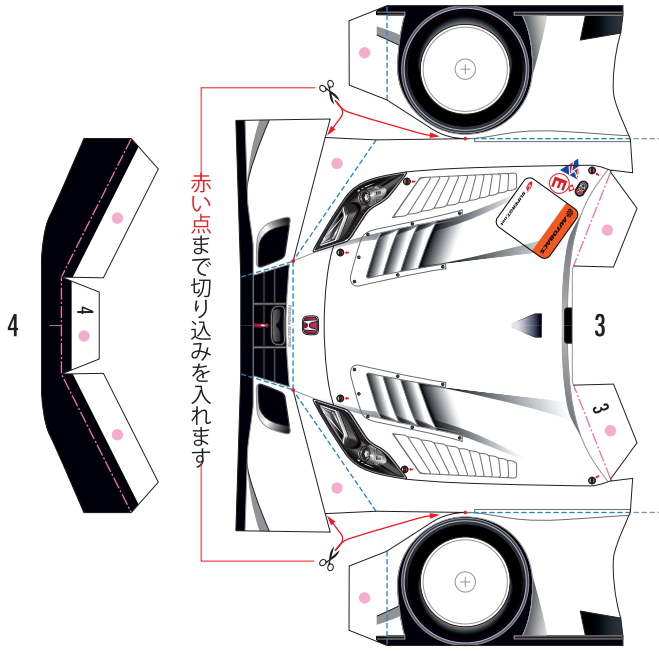

ボディ左右のゼッケンです、好きな番号を書いて貼りましょう。

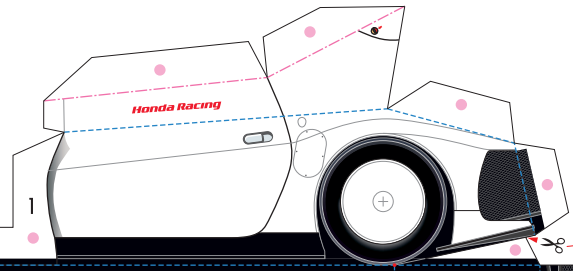

- 切る線
- - - 山折り
- · - 谷折りのりしろ
- 貼り合わせガイド線
- ✂ 切り抜くところ
- ✂ 切り込みを入れるところ

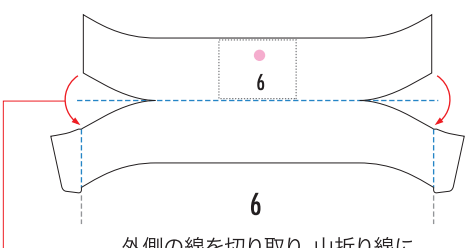
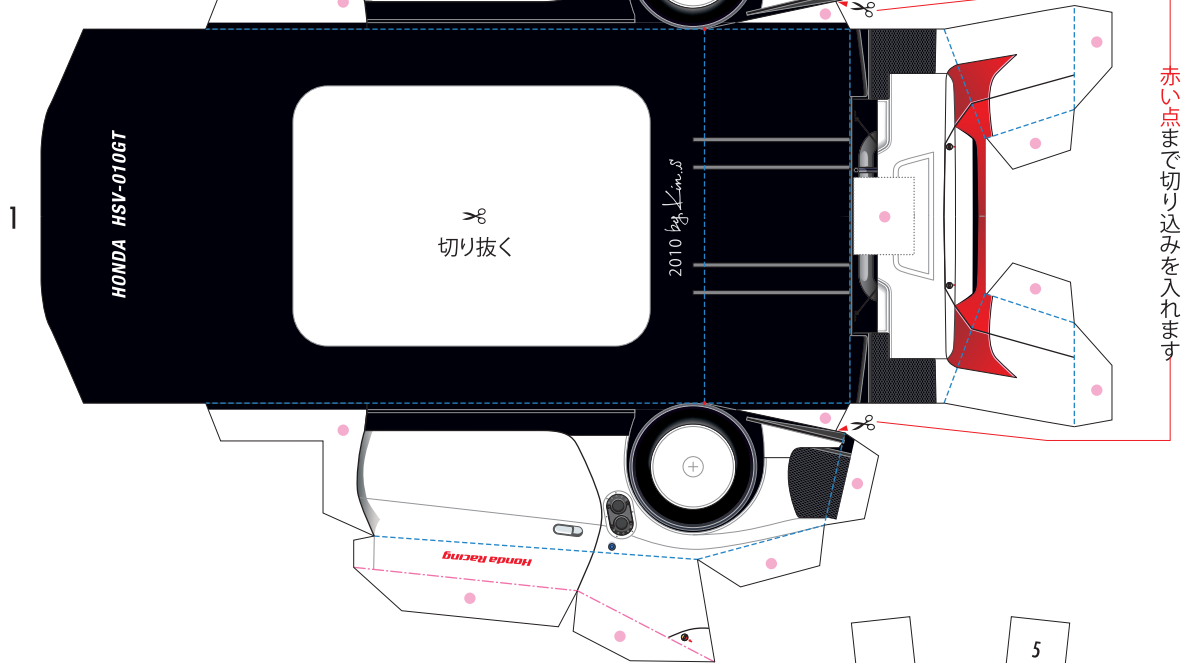

外側の線を切り取り、山折り線に沿って裏同士を貼り合わせます。

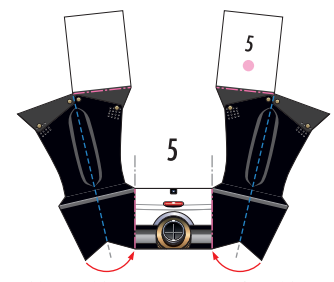

外側の線を切り取り、山折り線に沿って裏同士を貼り合わせます。