



EPSON NAKAJIMA RACING EPSON NSX Transporter Hed Tractor

1:24 Paper Craft Sheet 1



キャブ/フロントまわり用パーツ 1~21

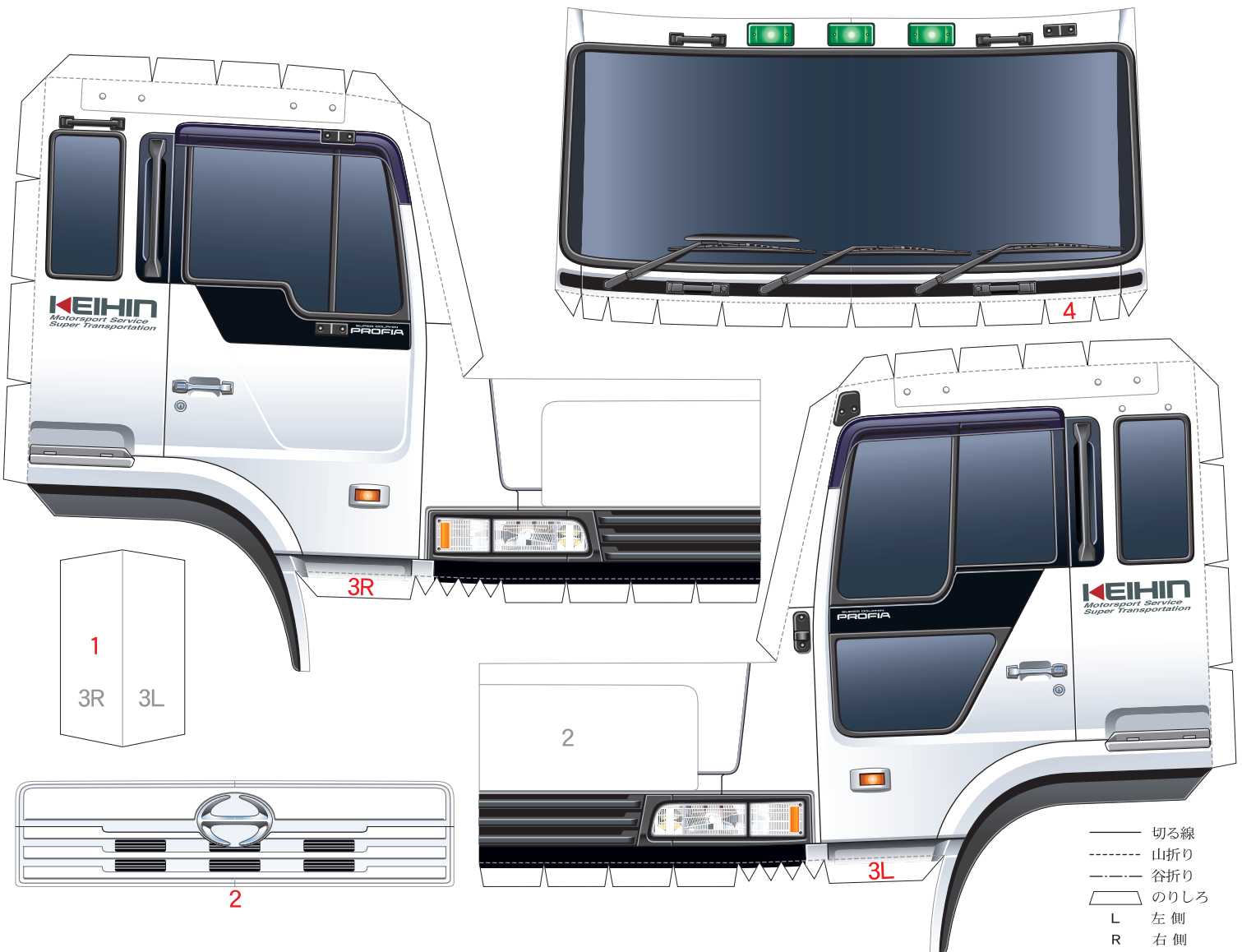
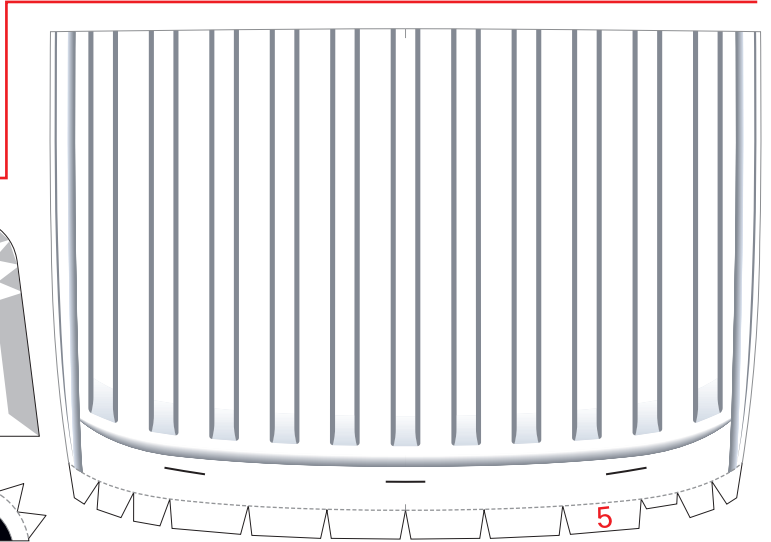
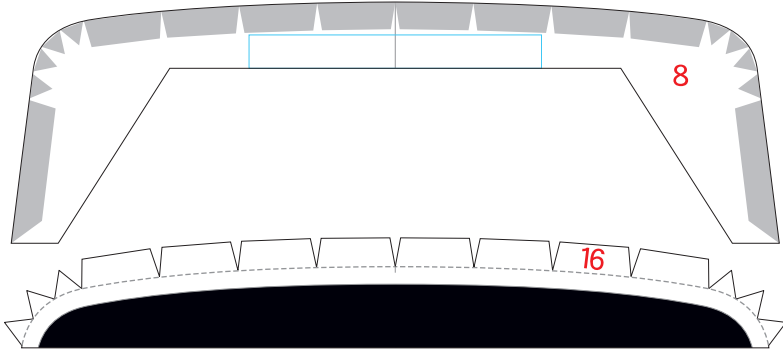

- 切る線
- - - 山折り
- · - 谷折り
- のりしろ
- L 左側
- R 右側



Transporter Hed Tractor Sheet 2

キャブ/フロントまわり用パーツ 1~21

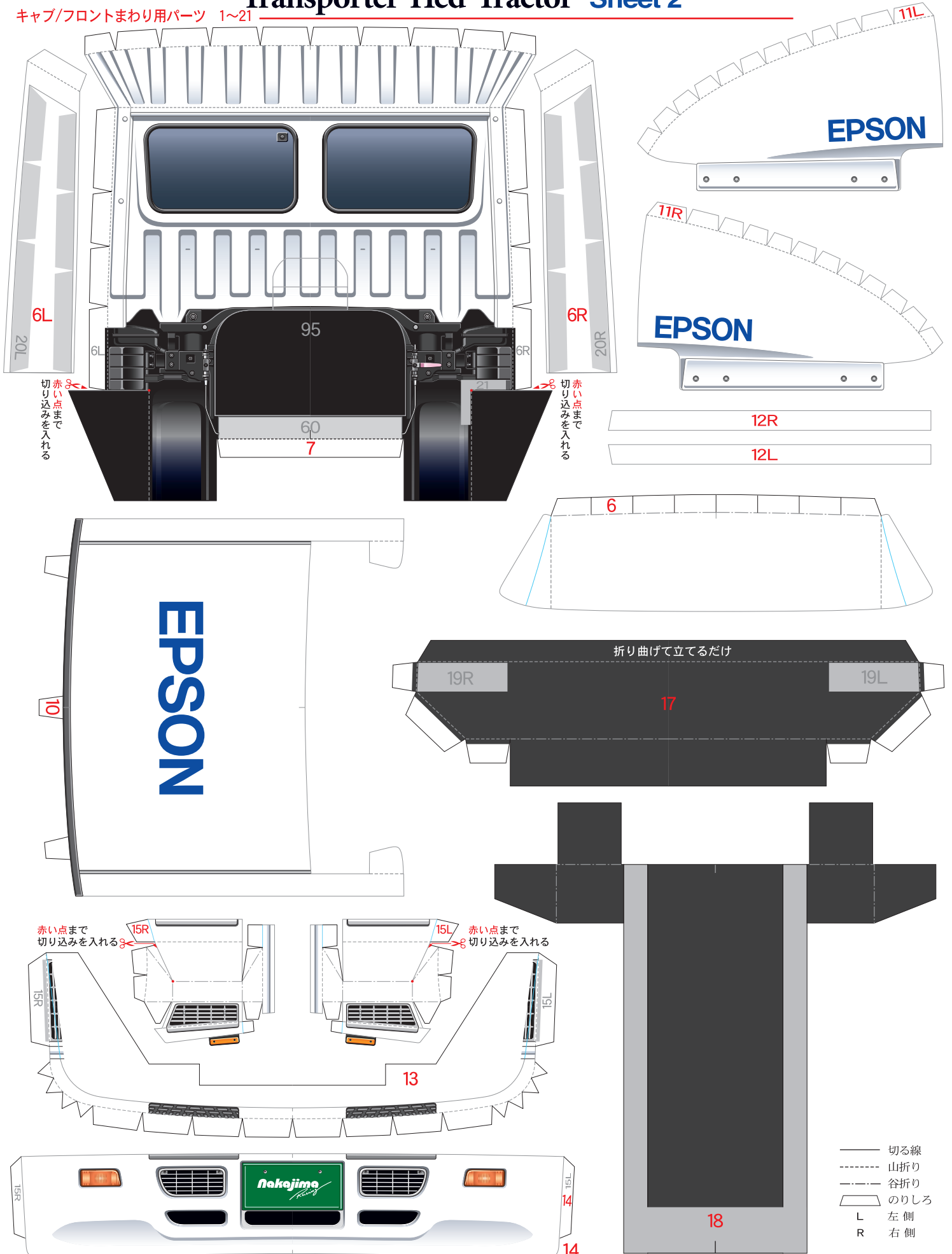

— 切る線
 - - - 山折り
 - · - 谷折り
 △ のりしろ
 L 左側
 R 右側

シャシーパーツ 22~41

Transporter Hed Tractor Sheet 3

キャブ/フロントまわり用パーツ 1~21

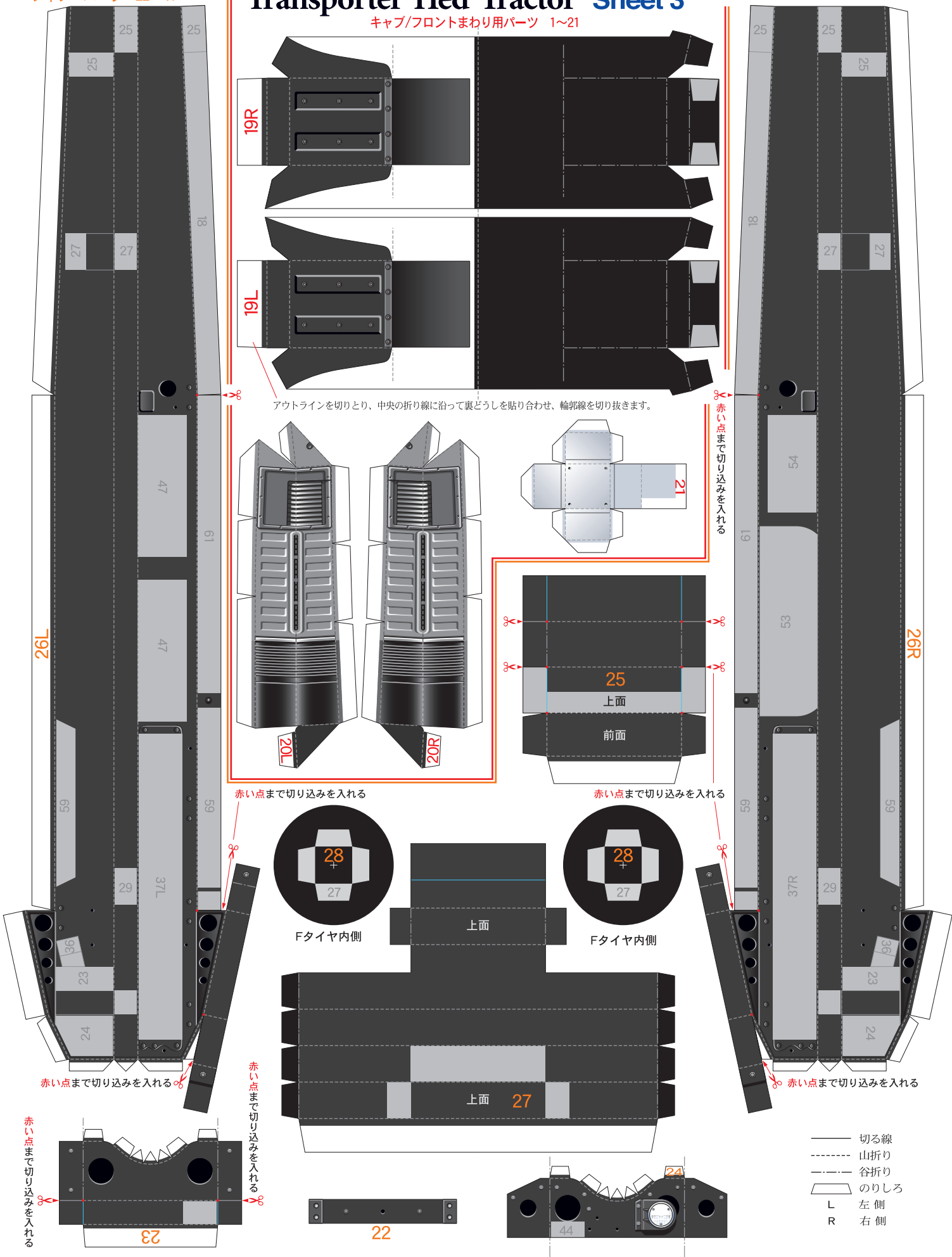

アウトラインを切りとり、中央の折り線に沿って裏どうしを貼り合わせ、輪郭線を切り抜きます。

赤い点まで切り込みを入れる

赤い点まで切り込みを入れる

赤い点まで切り込みを入れる

赤い点まで切り込みを入れる

赤い点まで切り込みを入れる

赤い点まで切り込みを入れる

- 切る線
- - - 山折り
- · - 谷折り
- == のりしろ
- L 左側
- R 右側

Transporter Hed Tractor Sheet 4

シャシーパーツ 22~41

付属パーツ 42~61

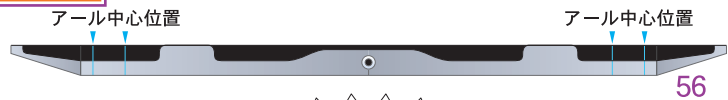
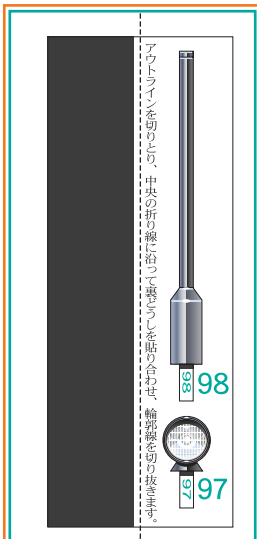
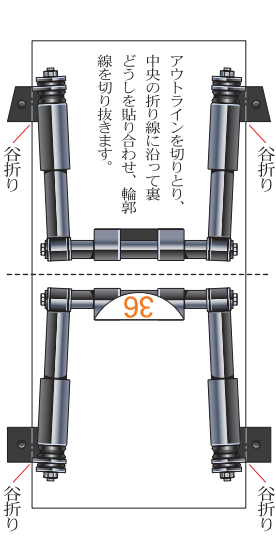
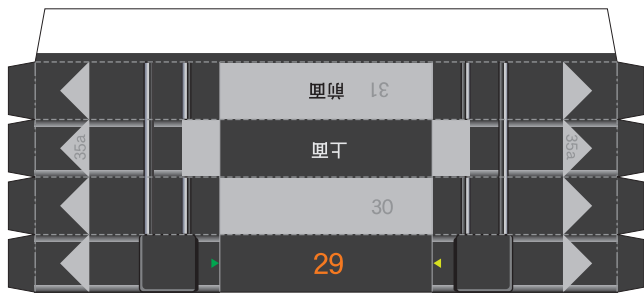
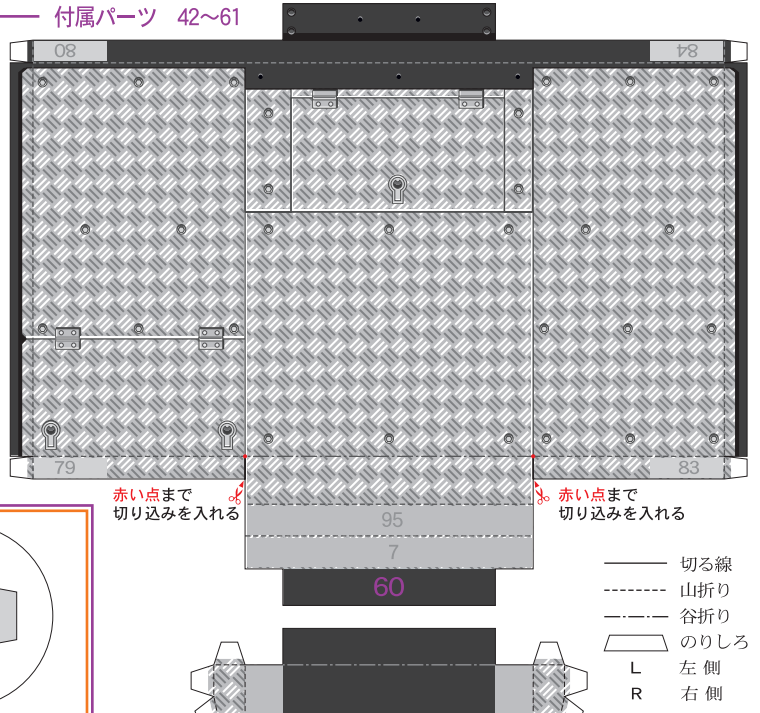
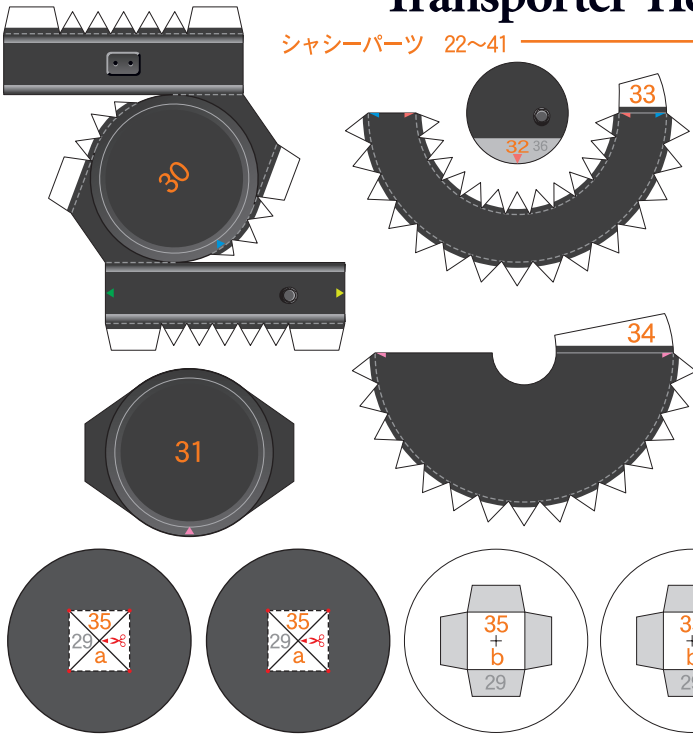

フィニッシュパーツ 77~99

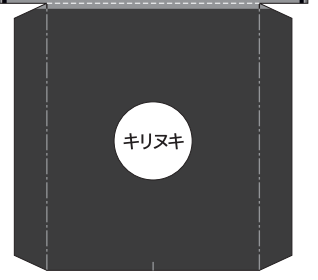
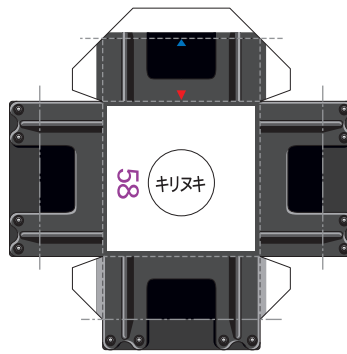
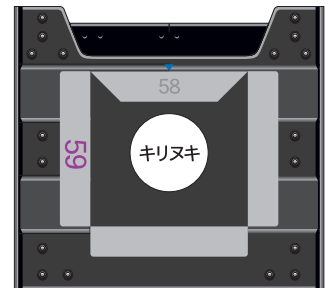
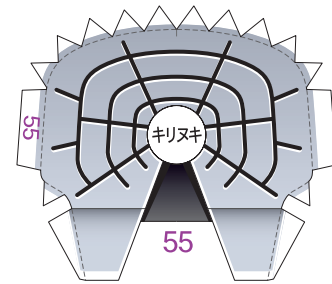
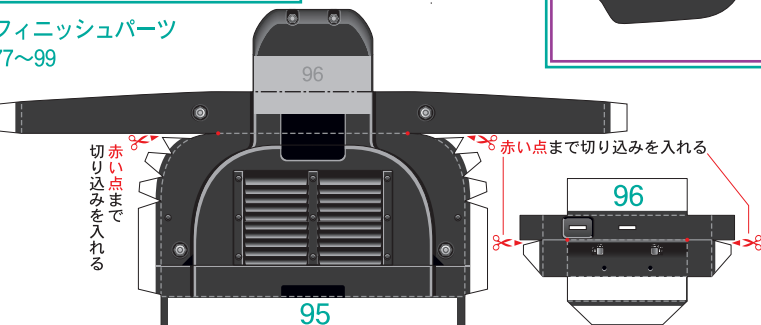



シャシーパーツ 22~41

Transporter Hed Tractor Sheet 5

付属パーツ 42~61

38R

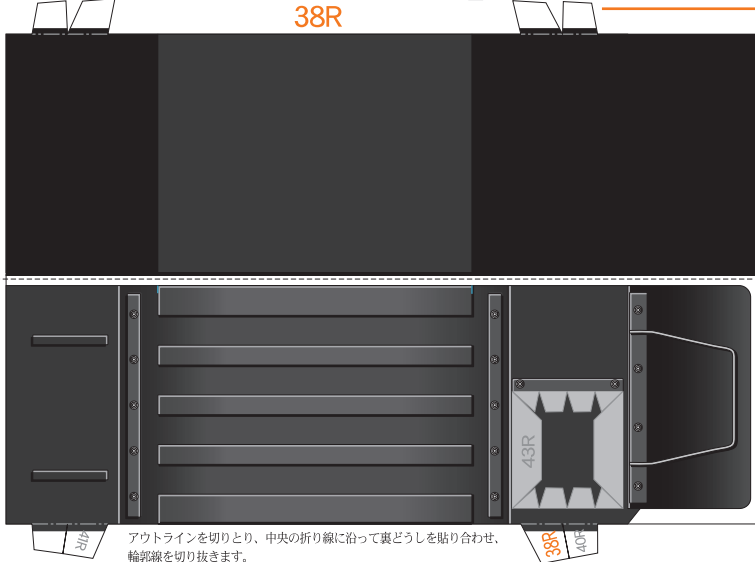

アウトラインを切りとり、中央の折り線に沿って裏どうしを貼り合わせ、輪郭線を切り抜きます。

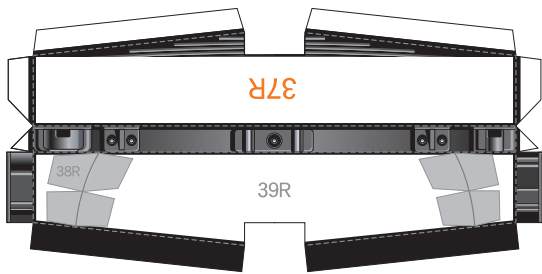

38L

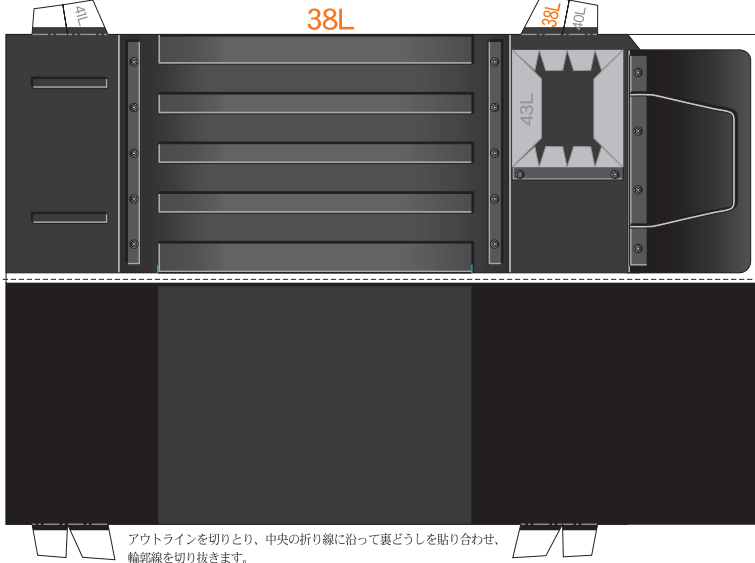

アウトラインを切りとり、中央の折り線に沿って裏どうしを貼り合わせ、輪郭線を切り抜きます。

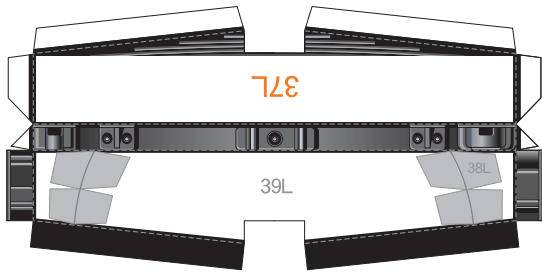

40R

39R

41R



41L

39L

40L

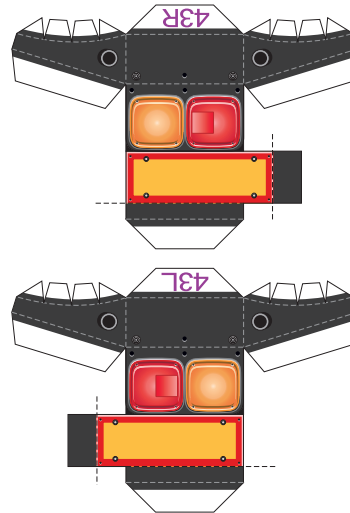

44

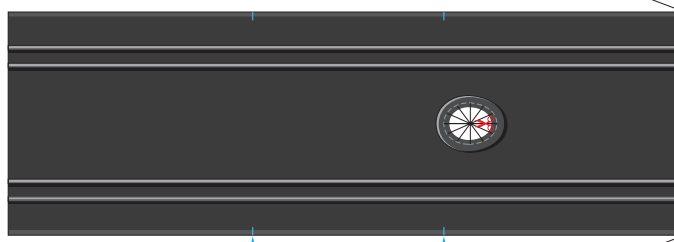

47

アール中心位置

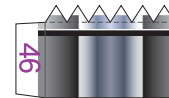

45 ▲継ぎ目位置合わせ印

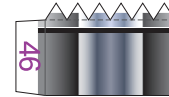

45 ▲継ぎ目位置合わせ印

- 切る線
- - - 山折り
- · - 谷折り
- ◡ のりしろ
- L 左側
- R 右側

アール中心位置

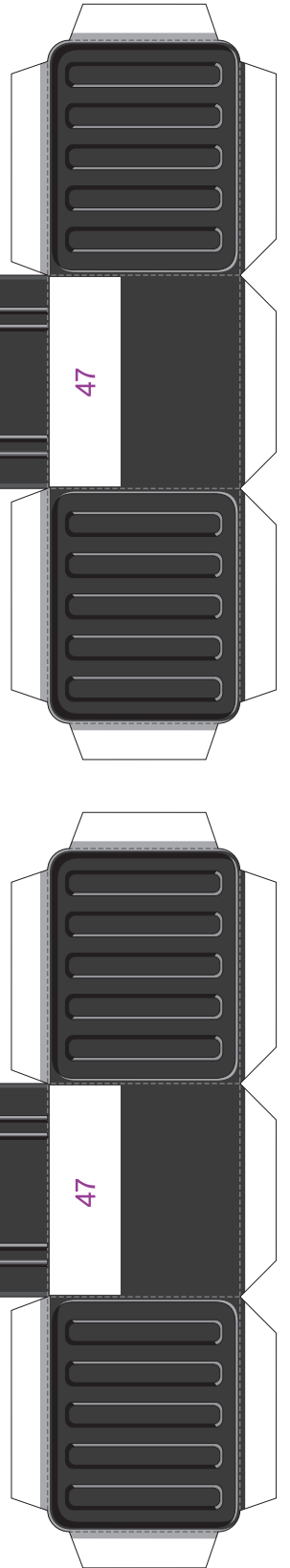

47



付属パーツ 42~61

Transporter Hed Tractor Sheet 6

— 切る線
 - - - 山折り
 - - - 谷折り
 のりしろ
 L 左側
 R 右側

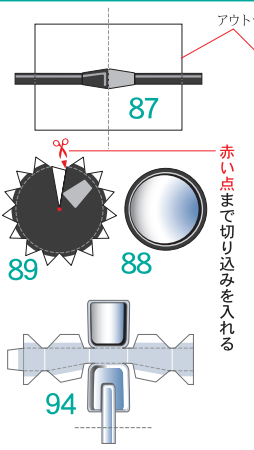
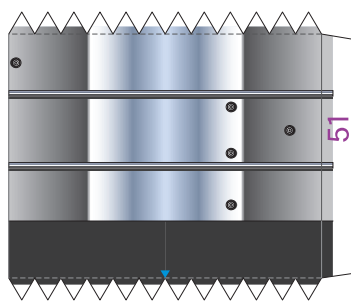
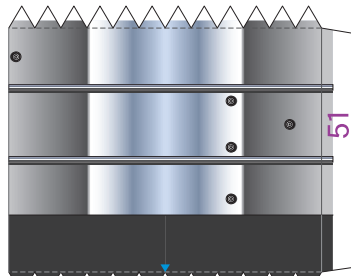
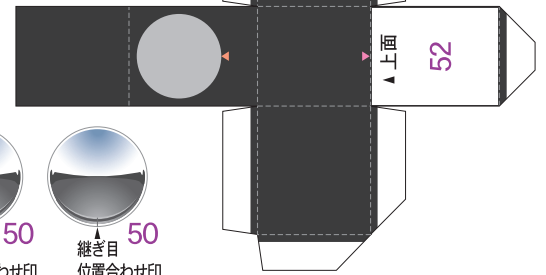
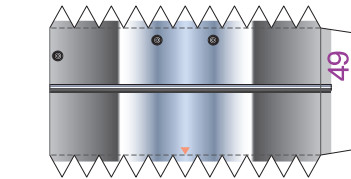
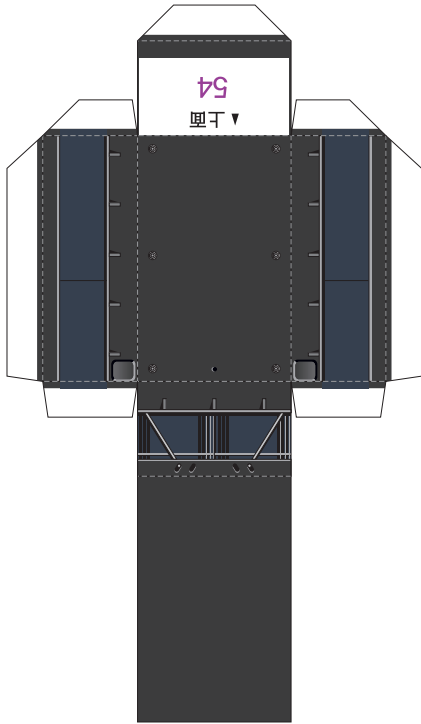

アウトラインを切りとり、中央の折り線に沿って裏どうしを貼り合わせ、輪郭線を切り抜きます。

赤い点まで切り込みを入れる

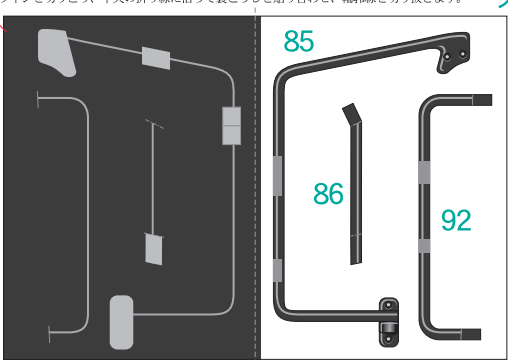

フィニッシュパーツ 77~99

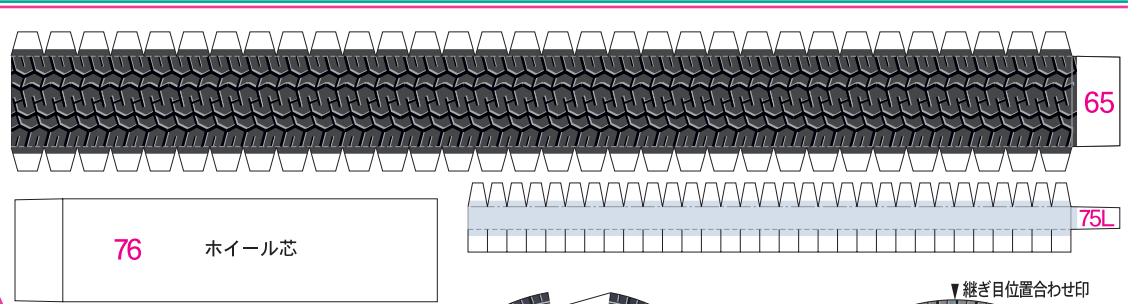
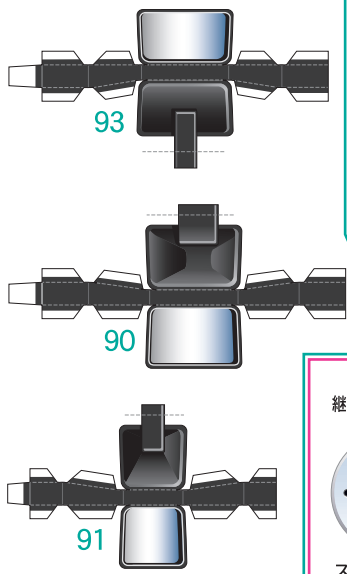
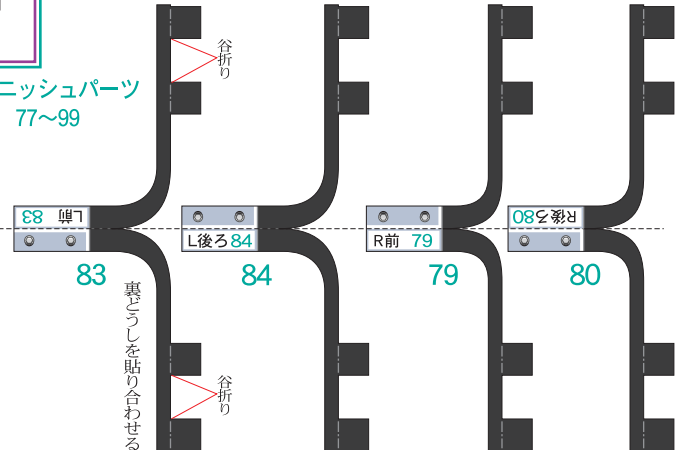

タイヤパーツ 62~76 (スベアタイヤパーツ)

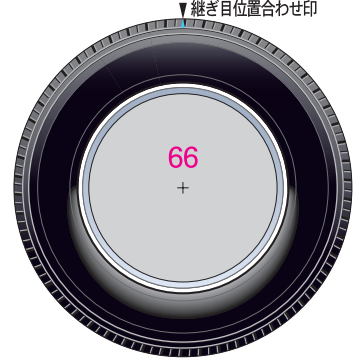
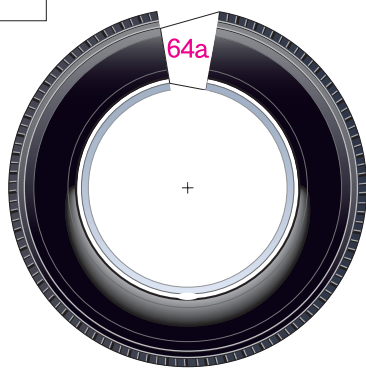
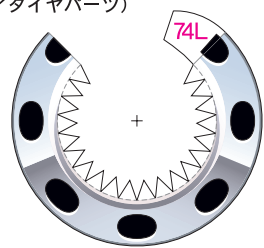
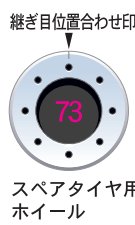



Transporter Hed Tractor Sheet 7

タイヤパーツ 62~76

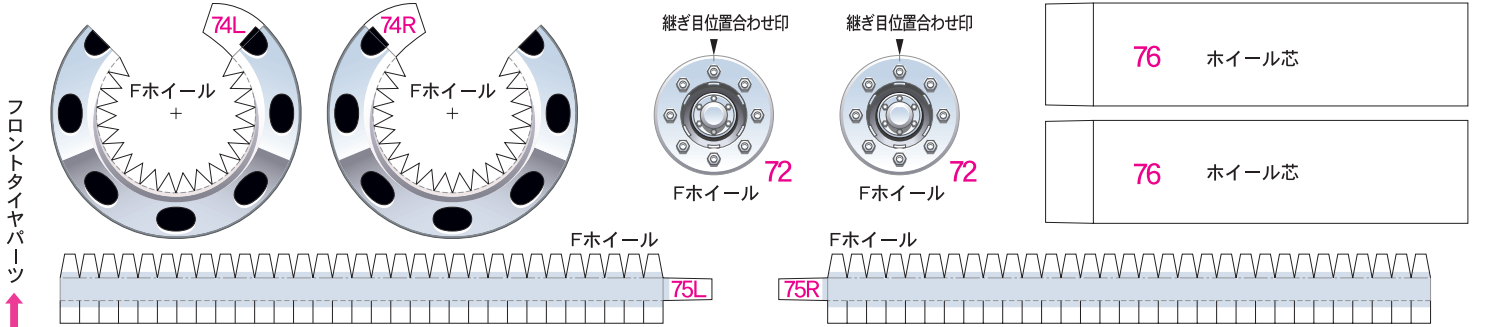
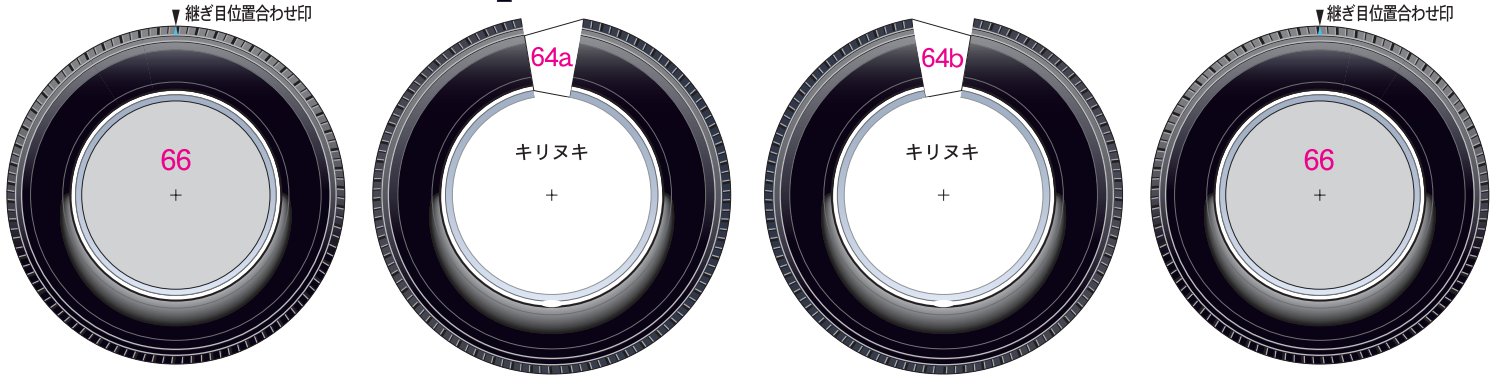

76	ホイール芯
76	ホイール芯

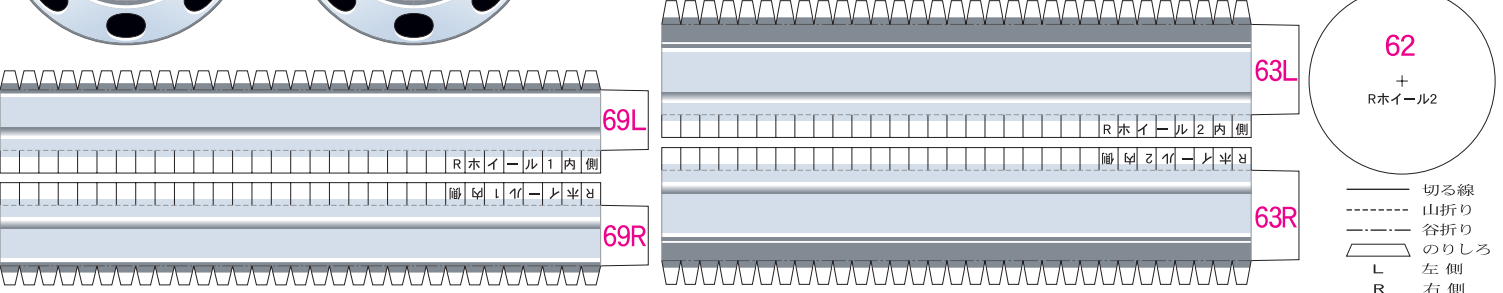
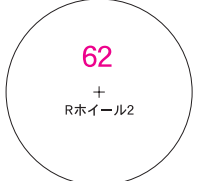
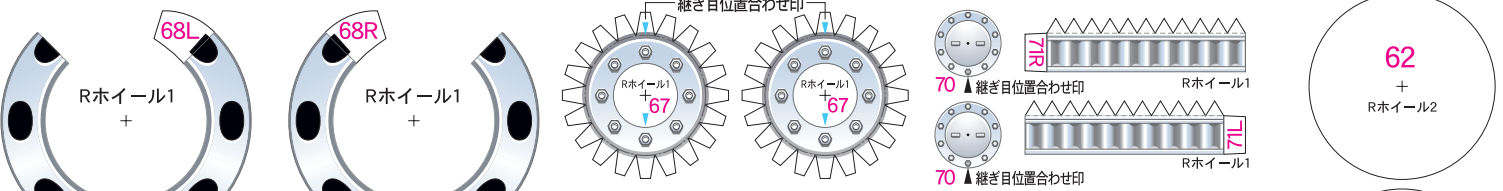
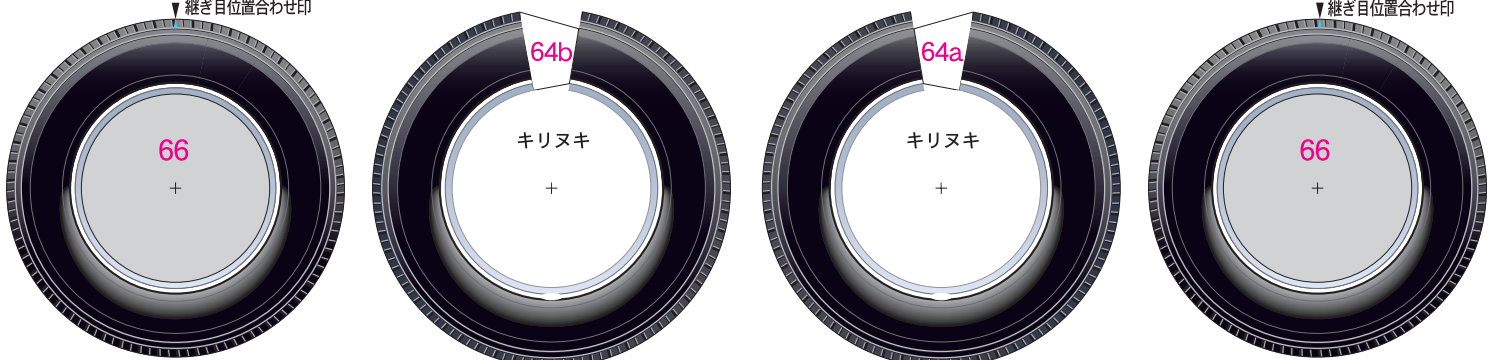
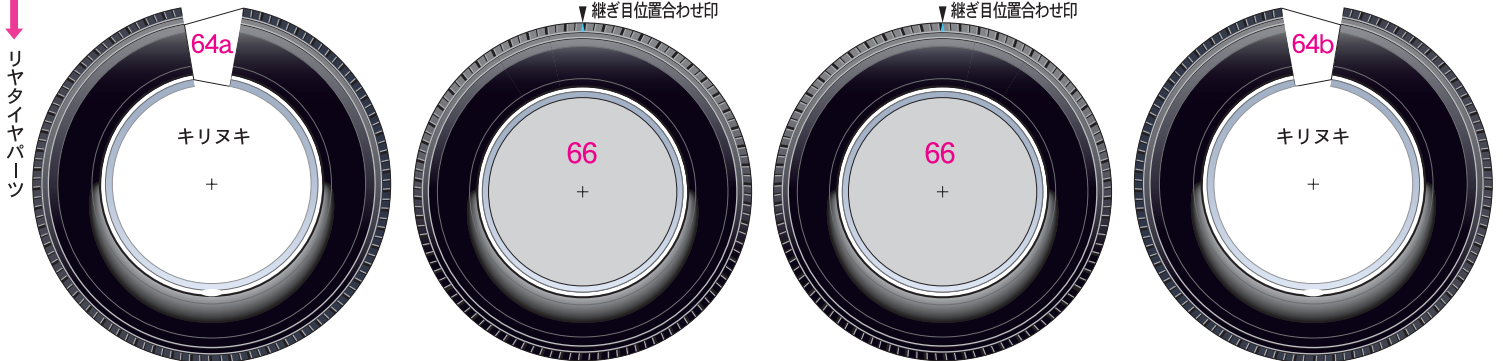

- 切る線
- - - 山折り
- - - 谷折り
- のりしろ
- L 左側
- R 右側



Transporter Hed Tractor Sheet 8

フィニッシュパーツ 77~99

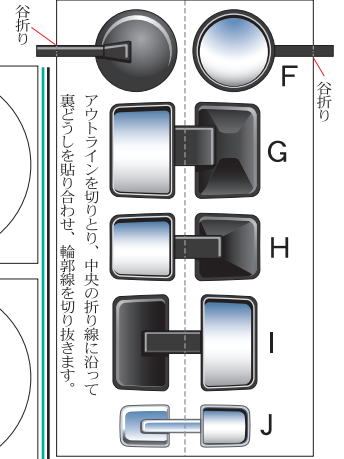
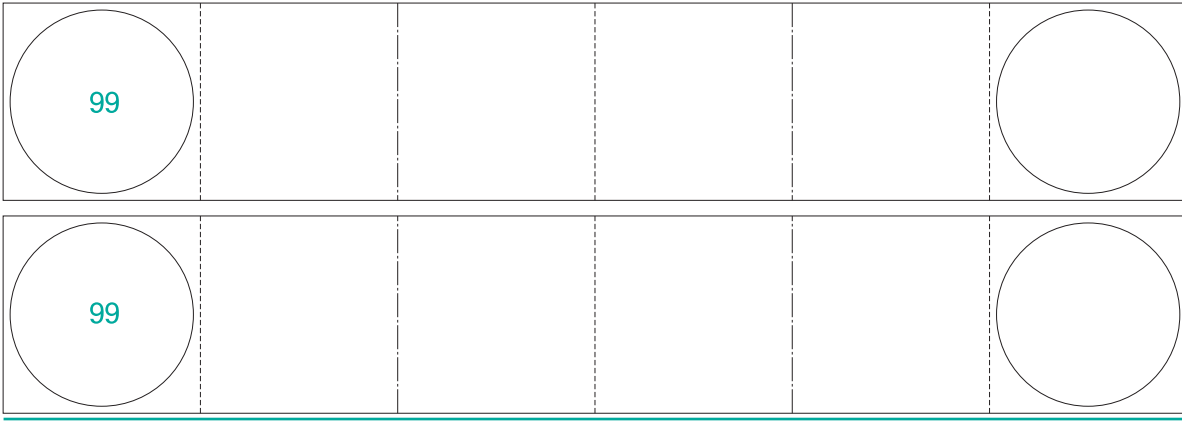

タイヤパーツ 62~76

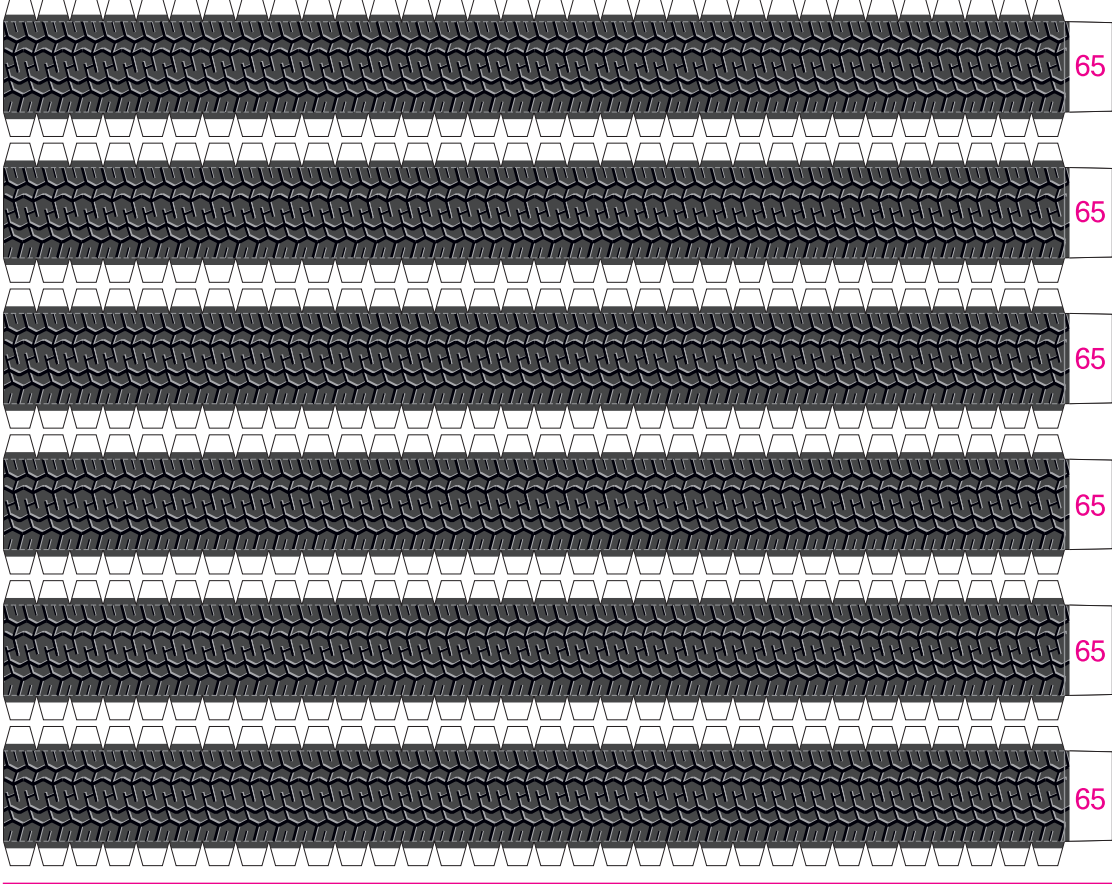

▼継ぎ目位置合わせ印

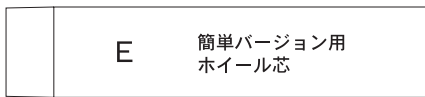
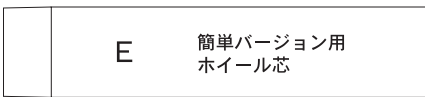
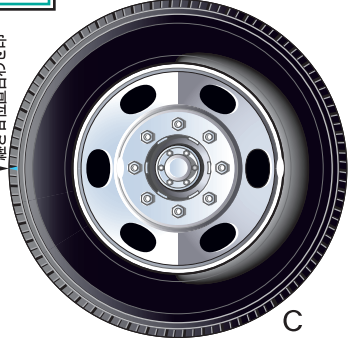

簡単バージョン用パーツ
A~J

