

# SUPER GT 2016 SERIES GT500

## Epson Nakajima Racing Epson NSX CONCEPT-GT

1:24 Scale Paper Craft

Sheet 1

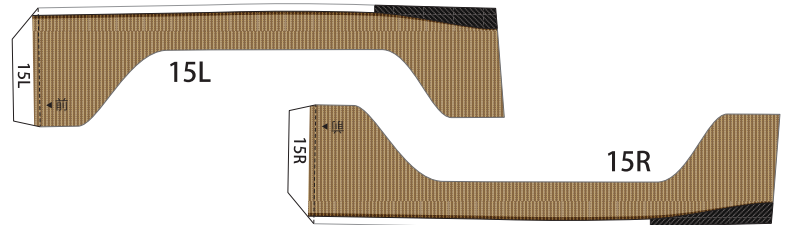
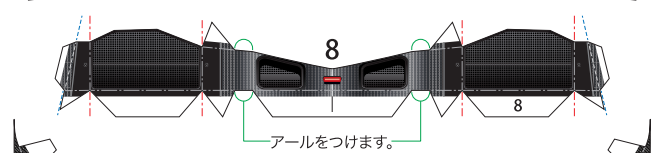
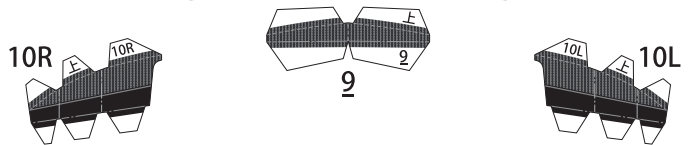
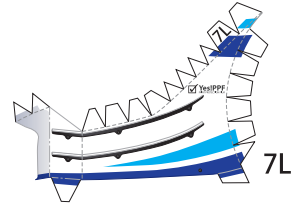
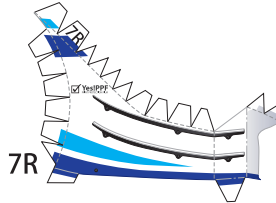
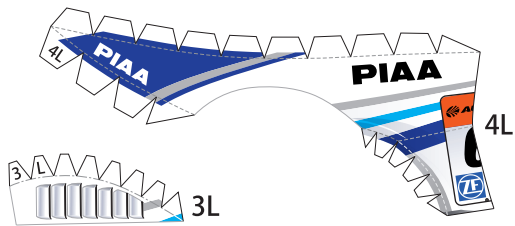
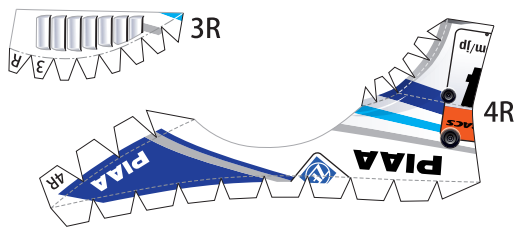

山折り線に沿って裏同士を貼り合わせます

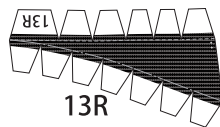
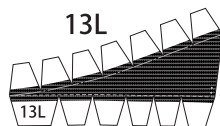

山折り線に沿って裏同士を貼り合わせます

— 切る線  
 - - - 山折り  
 - - - 谷折り  
 L 左側  
 R 右側  
 を表しています

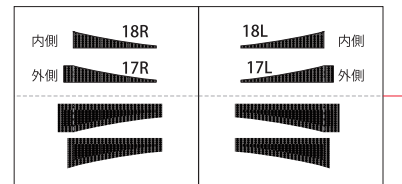

外側の線を切り取り、山折り線に沿って裏同士を貼り合わせてから、はさみマークがある面を切り取ります。

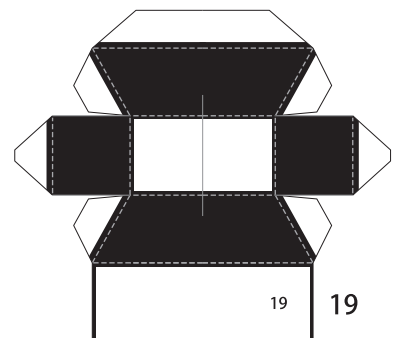
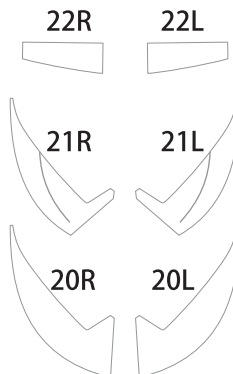

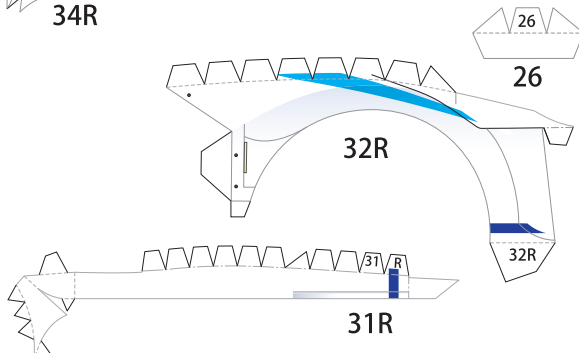
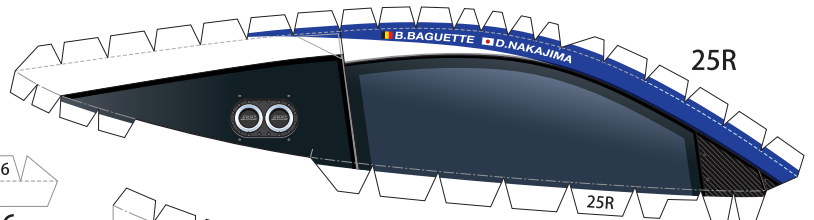
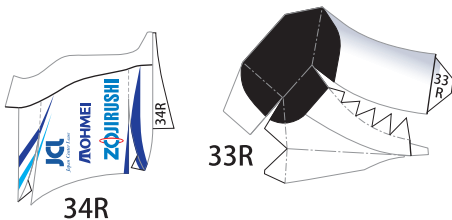
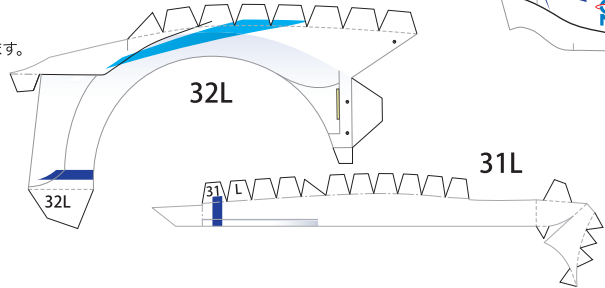
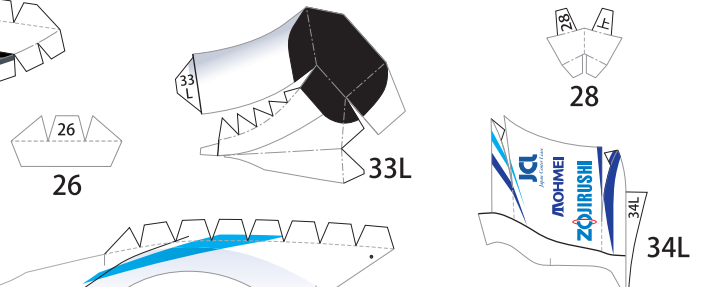
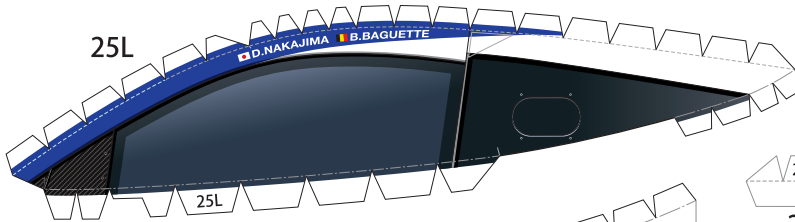
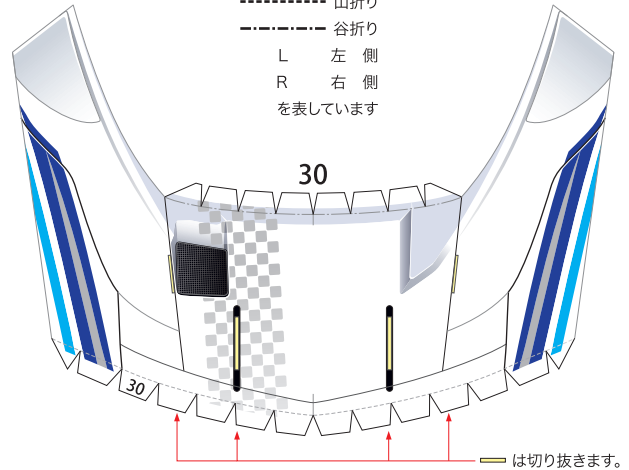
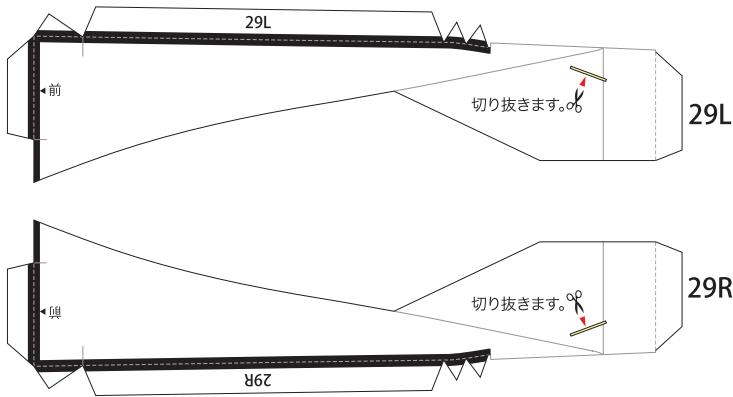
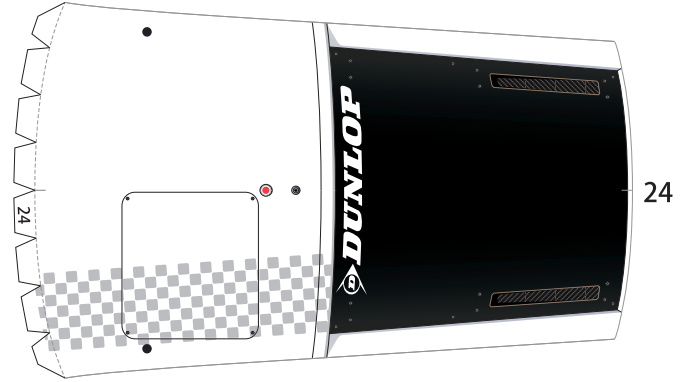
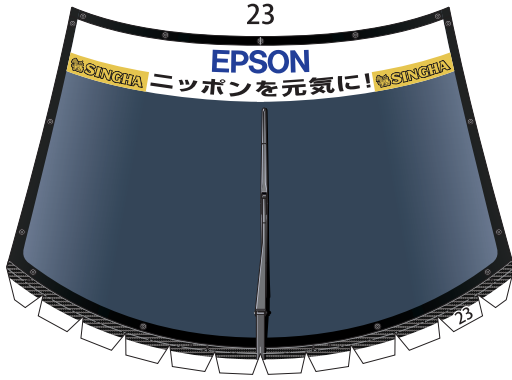



1:24 Scale Paper Craft

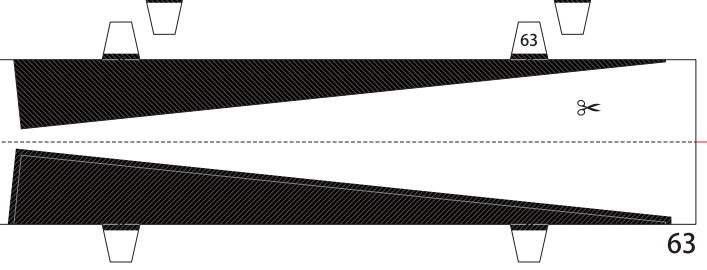
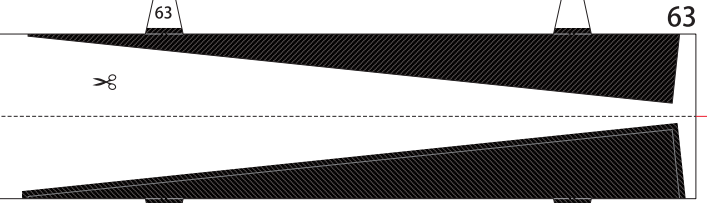
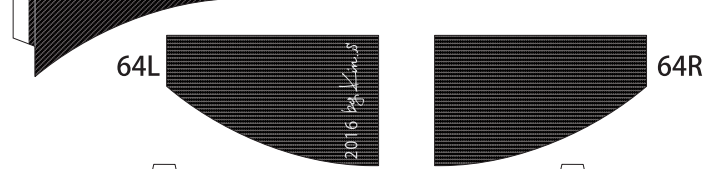
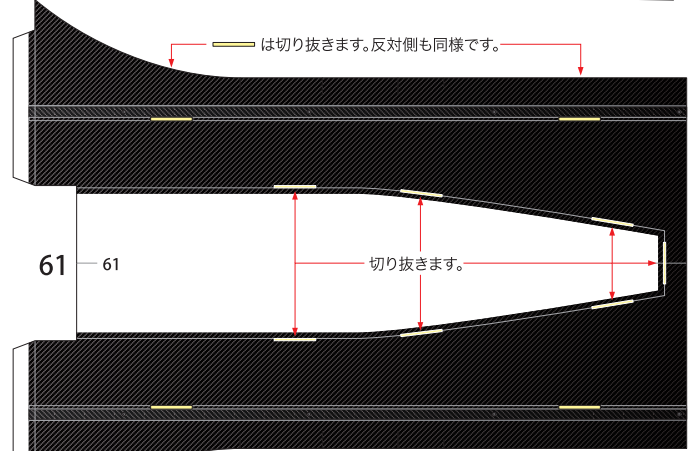
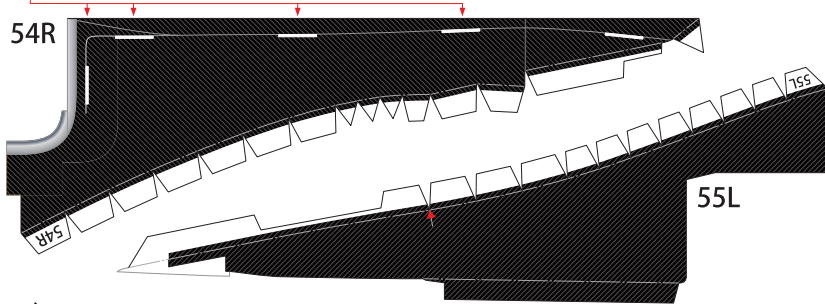
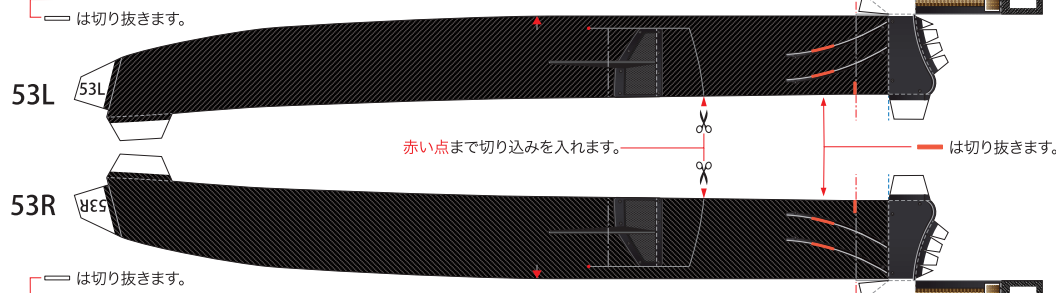
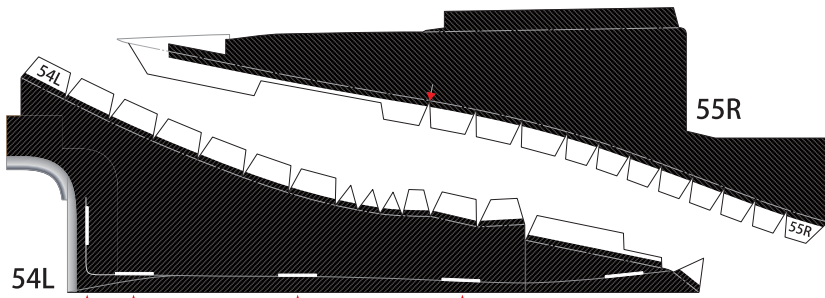

— 切る線  
 - - - 山折り  
 - · - 谷折り  
 L 左側  
 R 右側  
 を表しています

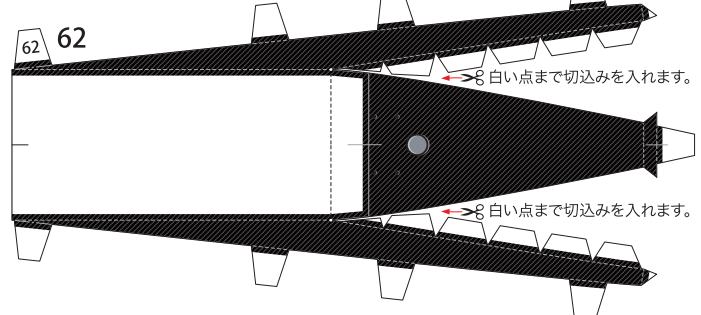
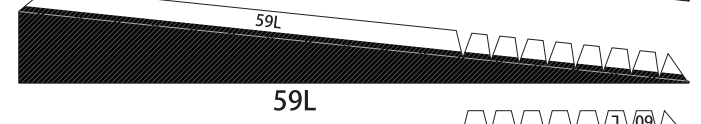
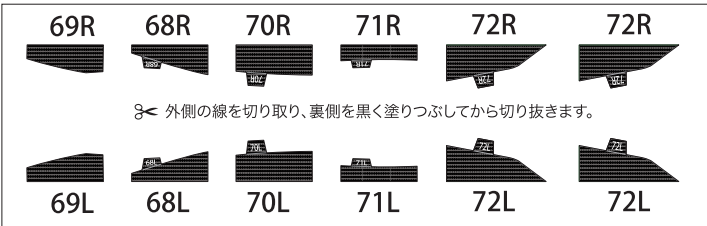
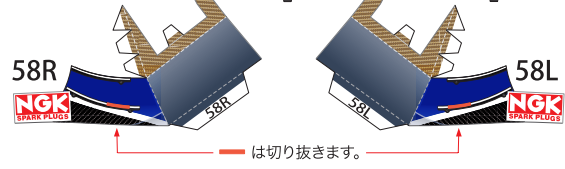
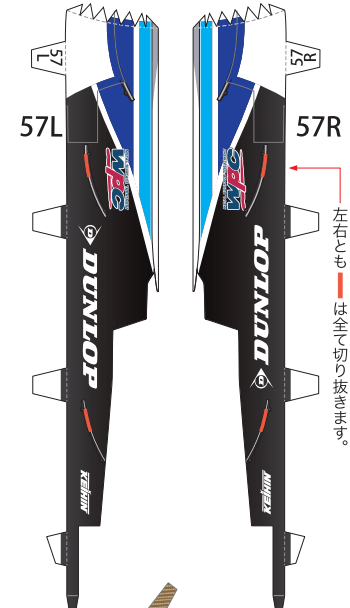
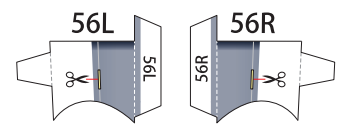

外側の線を切り取り、はみ出しているところ以外の裏同士を山折り線に沿って貼り合わせてから、はさみマークがある面を切り取ります。

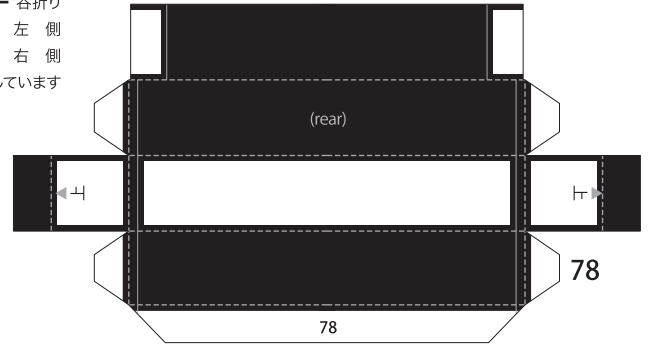
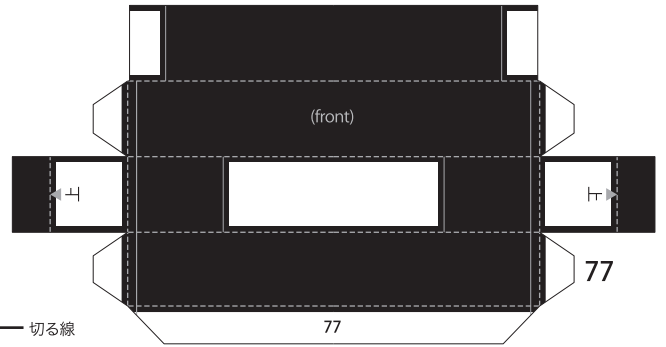
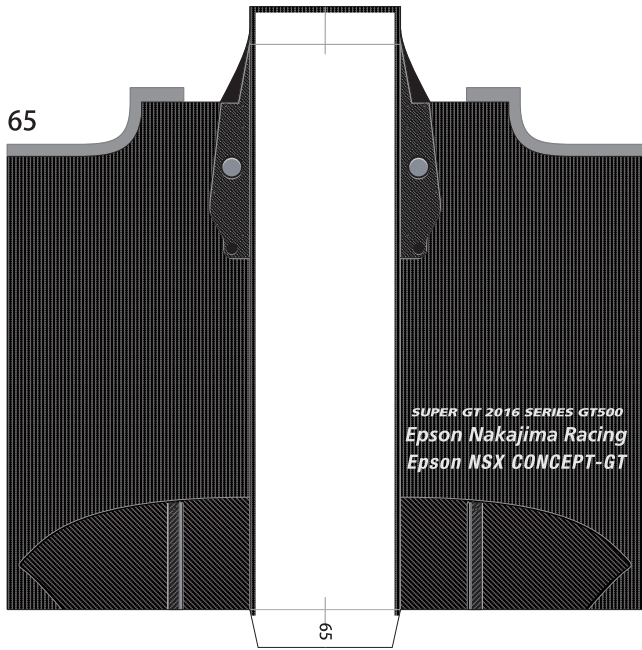

— 切る線  
 - - - 山折り  
 - - - 谷折り  
 L 左側  
 R 右側  
 を表しています

外側の線を切り取り、山折り線に沿って裏同士を貼り合わせてから、はさみマークがある面を切り取ります。

