

SUPER GT 2010 SERIES GT500

Epson Nakajima Racing EPSON HSV-010GT

1:24 Scale Paper Craft Sheet 1

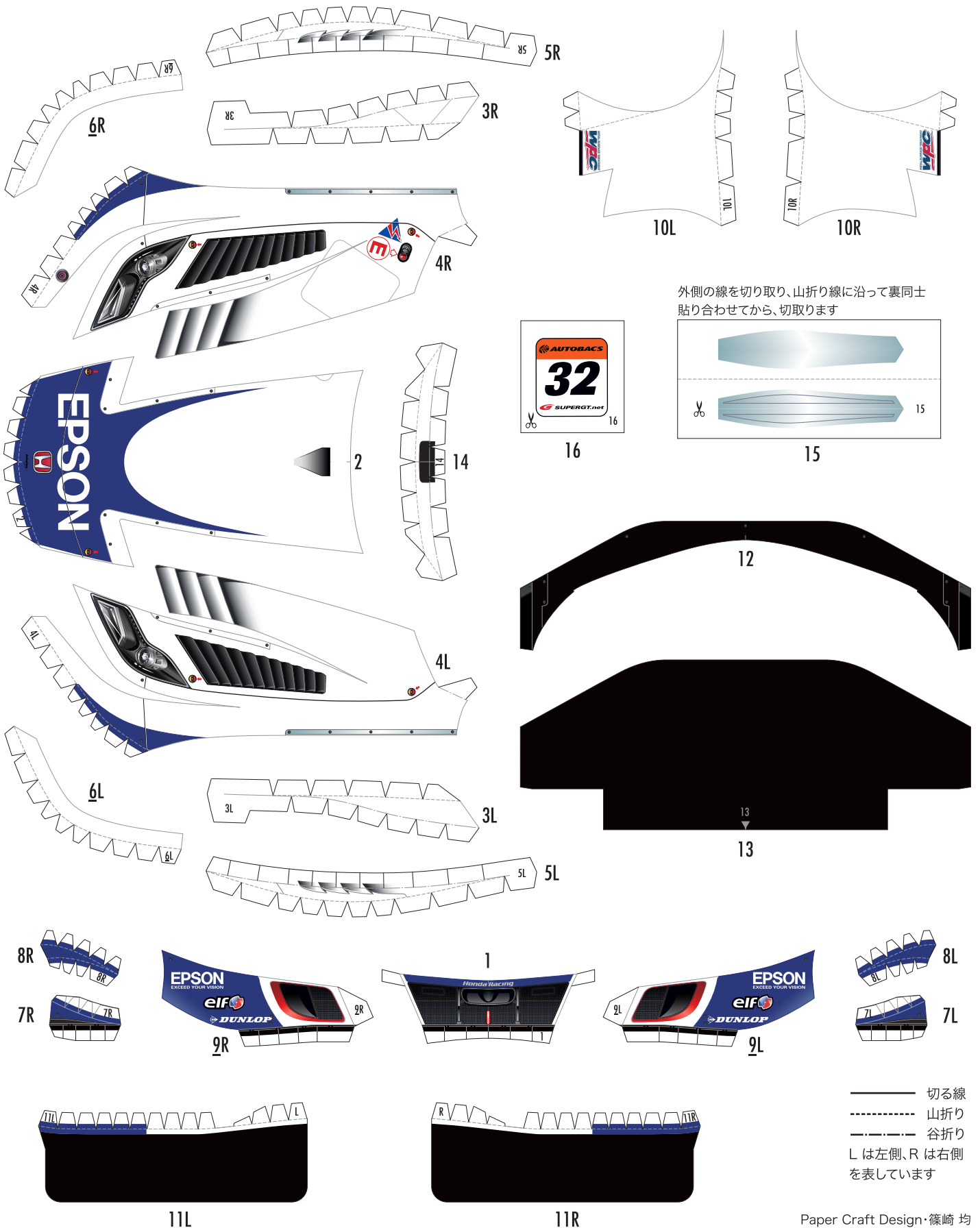

SUPER GT 2010 SERIES GT500 Epsilon Nakajima Racing EPSON HSV-010GT

1:24 Scale Paper Craft Sheet 2

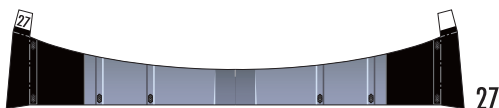
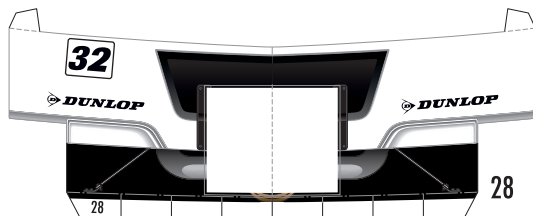
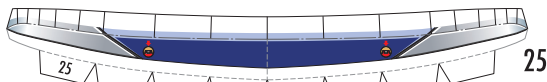
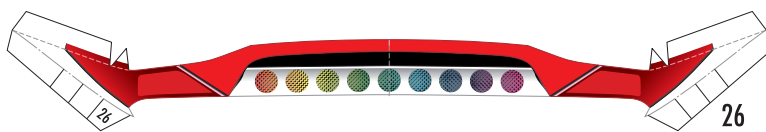
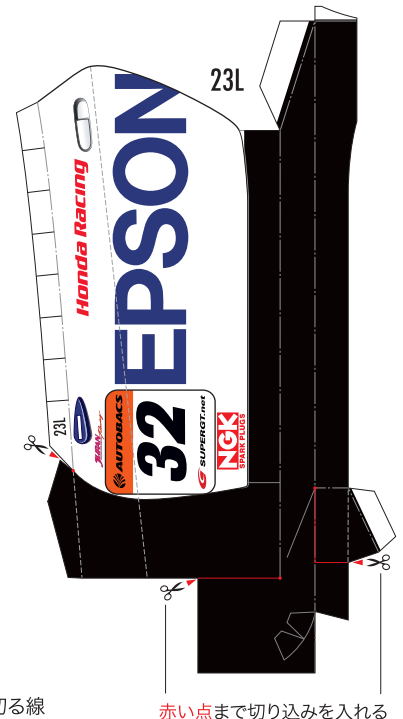
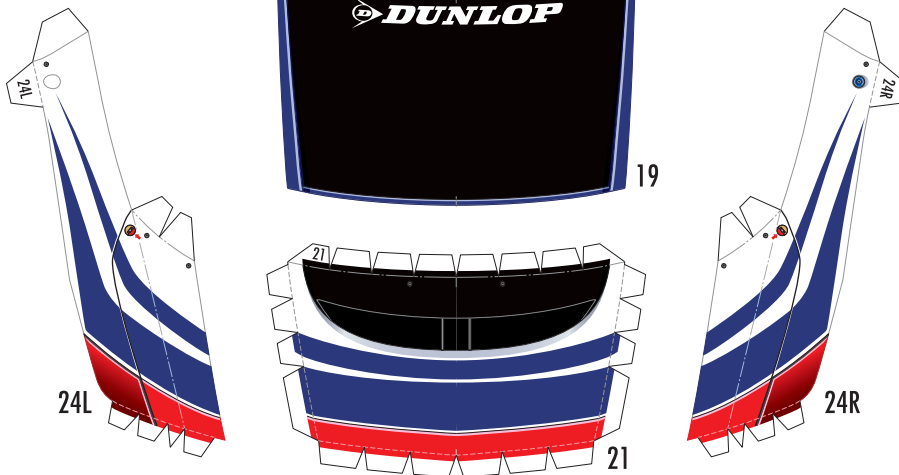
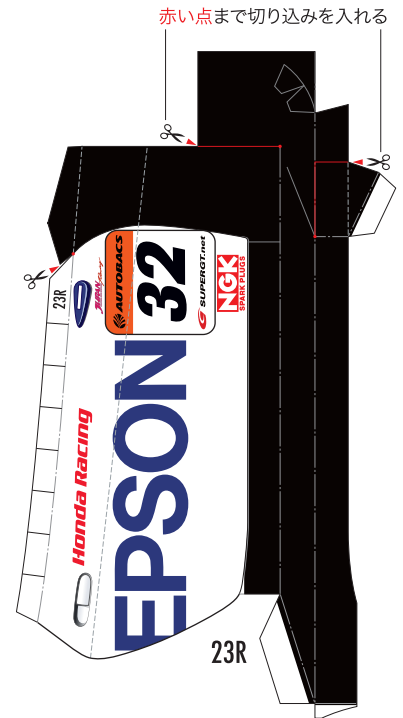
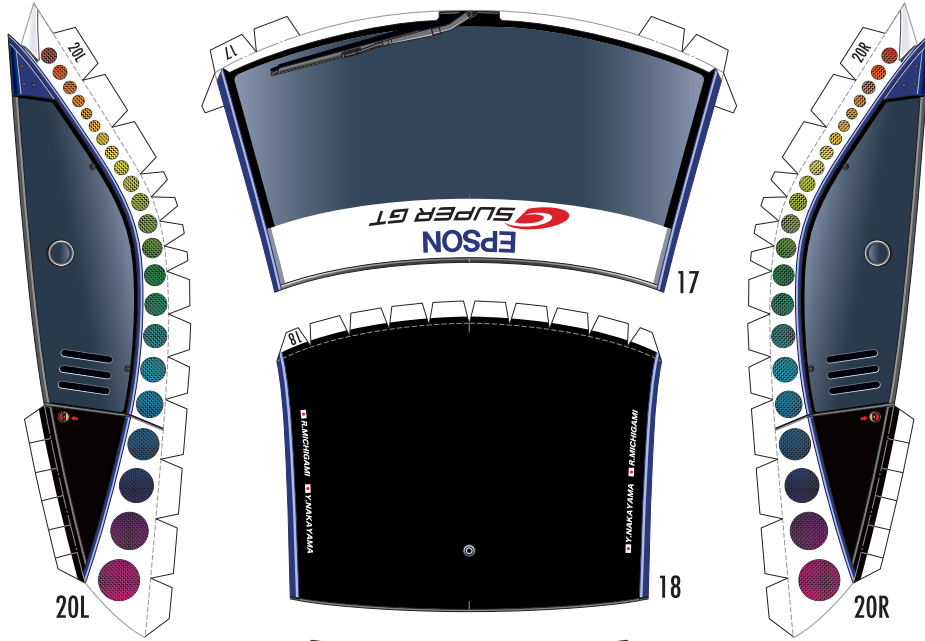

——— 切る線
 - - - - - 山折り
 - · - · - 谷折り
 Lは左側、Rは右側
 を表しています

赤い点まで切り込みを入れる

赤い点まで切り込みを入れる



SUPER GT 2010 SERIES GT500 Epsilon Nakajima Racing EPSON HSV-010GT

1:24 Scale Paper Craft Sheet 3

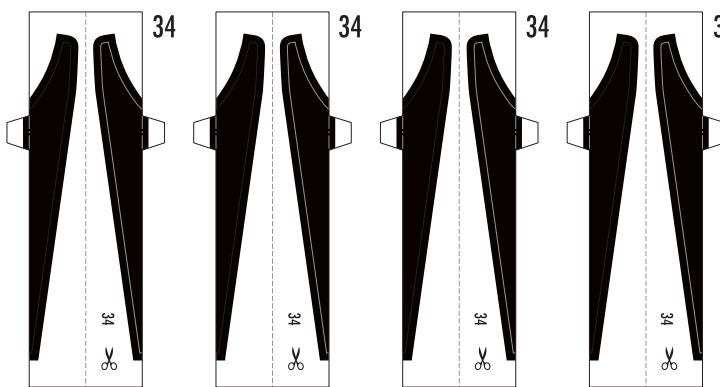
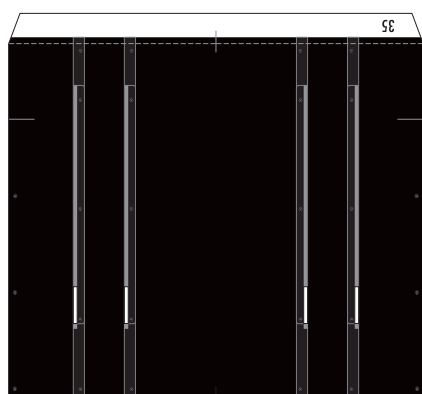
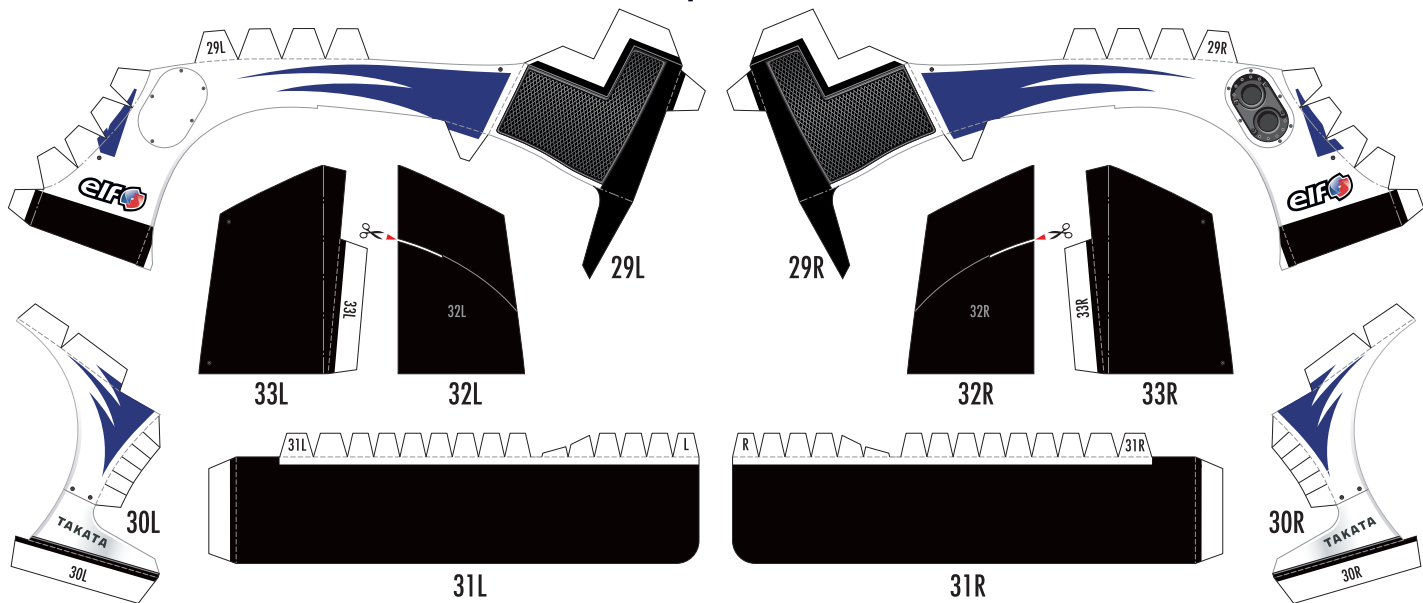

— 外側の線を切り取り、山折り線に沿って裏同士貼り合わせてから、切り取ります

—— 切る線
 - - - - 山折り
 - · - · 谷折り
 L は左側、R は右側を表しています

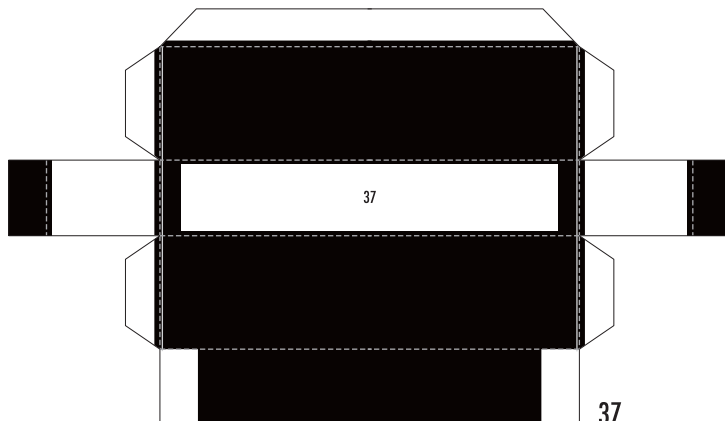
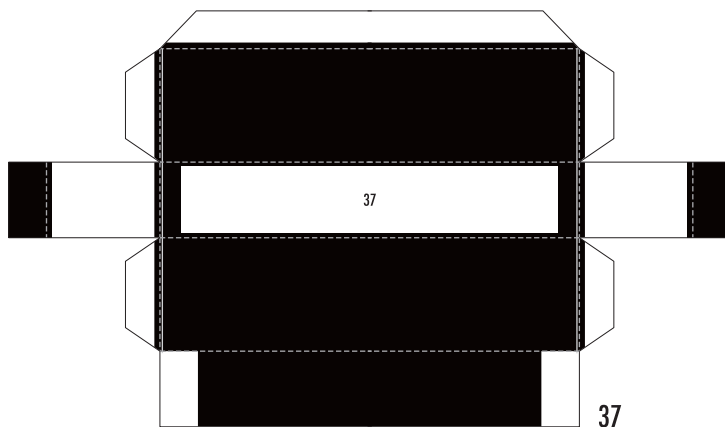
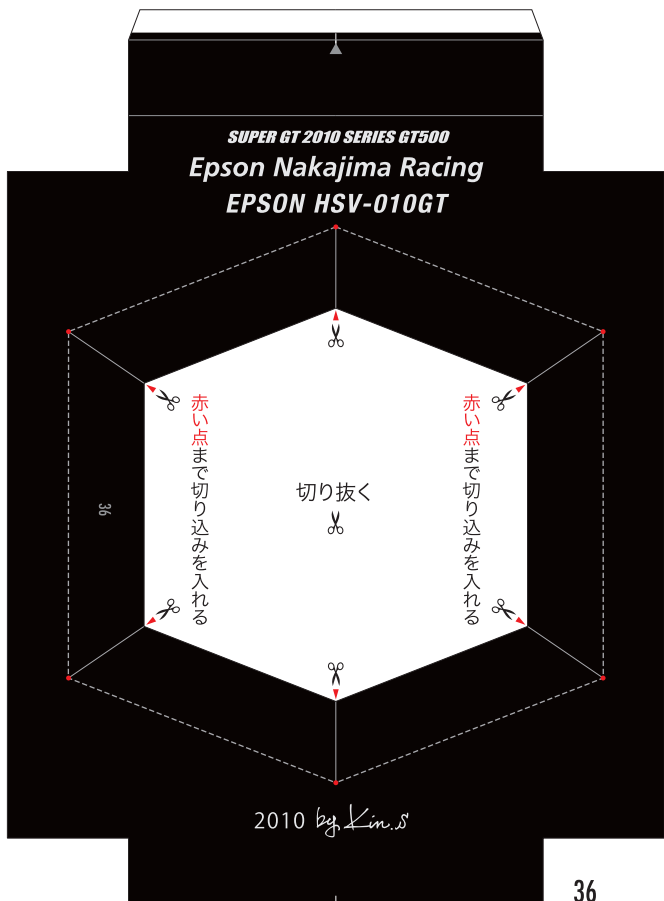

SUPER GT 2010 SERIES GT500 Epson Nakajima Racing EPSON HSV-010GT

1:24 Scale Paper Craft Sheet 4

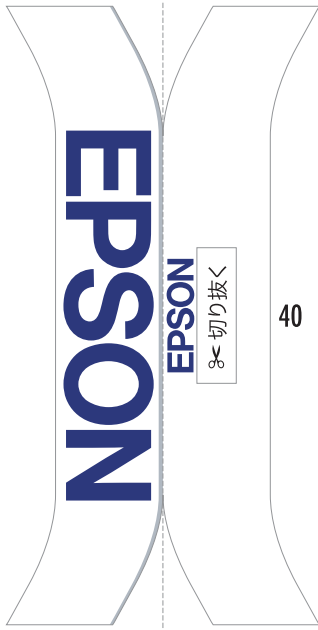

EPSON
✂️ 切り抜く

40

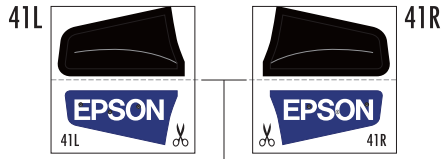

外側の線を切り取り、山折り線に沿って裏同士貼り合わせてから、切り取ります

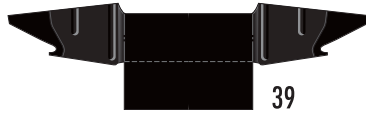

39

- 切る線
- - - 山折り
- · - 谷折り
- L は左側、R は右側を表しています

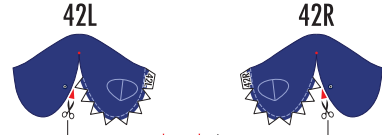
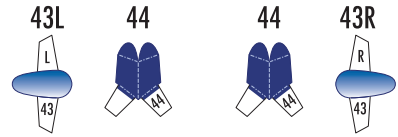

赤い点まで
切り込みを入れる

外側の線を切り取り、山折り線に沿って裏同士貼り合わせてから、切り取ります

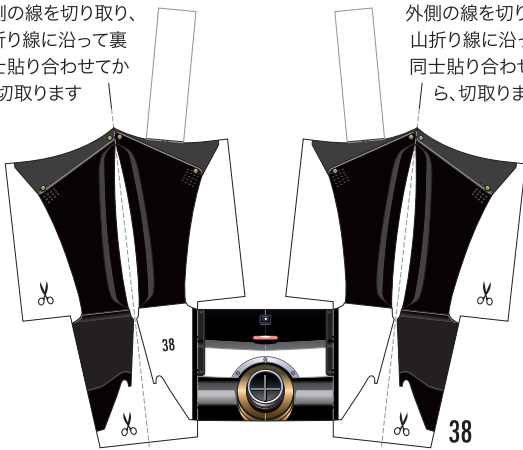

38

外側の線を切り取り、山折り線に沿って裏同士貼り合わせてから、切り取ります

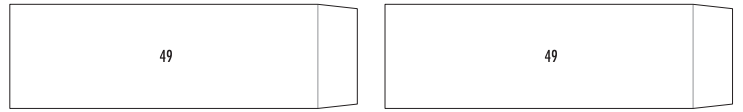

49

49

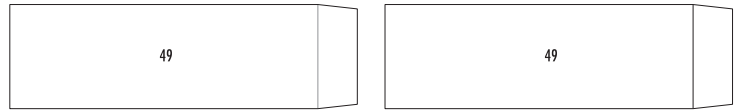

49

49

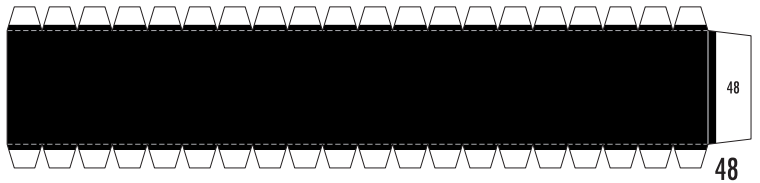

48

48

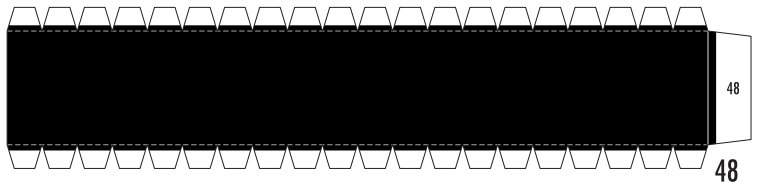

48

48

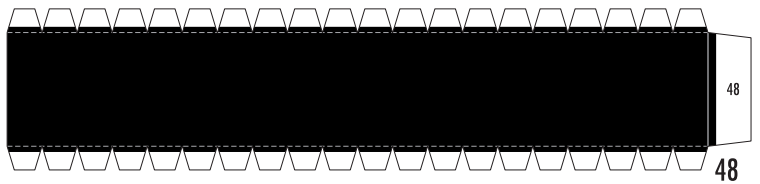

48

48

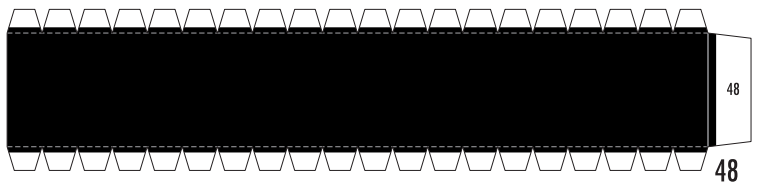

48

48

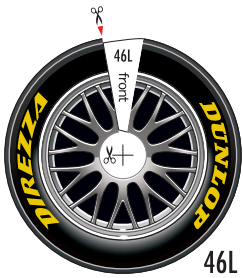

46L

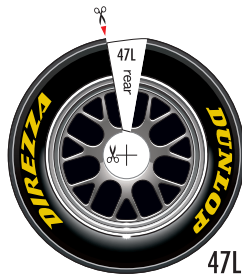

47L

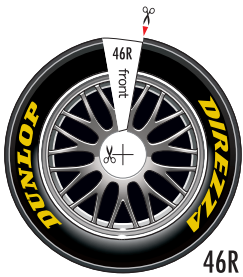

46R

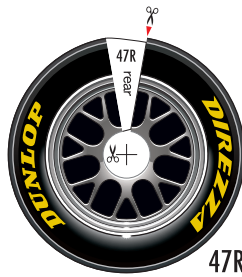

47R

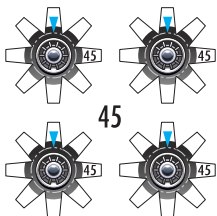

45

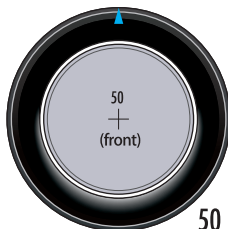

50

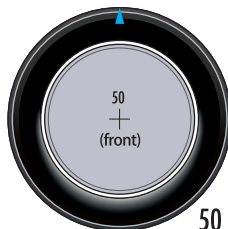

50



51



51